

Service Manual

Air Conditioner

CS-F50DD2E5 CU-L50DBE8



⚠ WARNING

This service information is designed for experienced repair technicians only and is not designed for use by the general public. It does not contain warnings or cautions to advise non-technical individuals of potential dangers in attempting to service a product. Products powered by electricity should be serviced or repaired only by experienced professional technicians. Any attempt to service or repair the product or products dealt with in this service information by anyone else could result in serious injury or death.

⚠ PRECAUTION OF LOW TEMPERATURE

In order to avoid frostbite, be assured of no refrigerant leakage during the installation or repairing of refrigeration circuit.

CONTENTS

	Page		Page
1 SERVICE INFORMATION	3	2.4. A brand-new control method using the latest in technology	7
1.1. Example of trouble at test operation	3	3 SPECIFICATION	9
1.2. Caution of test operation	3	3.1. CS-F50DD2E5 CU-L50DBE8	9
1.3. Caution during automatic address setting	3	4 DIMENSIONS	10
1.4. Operation Range	3	4.1. CS-F50DD2E5	10
2 FEATURES	4	4.2. CU-L50DBE8	11
2.1. Variety of excellent features	4	5 REFRIGERATION CYCLE	12
2.2. New low-noise outdoor units	5	6 BLOCK DIAGRAM	13
2.3. Greatly improved workability increases system renewal capability	6	6.1. CS-F50DD2E5	13

6.2. CU-L50DBE8	14	10 INSTALLATION INSTRUCTION	35
7 WIRING DIAGRAM	15	10.1. Pipe Length	35
7.1. CS-F50DD2E5	15	10.2. Indoor unit installation	36
7.2. CU-L50DBE8	16	10.3. Outdoor unit installation	45
8 OPERATION DETAILS	17	10.4. Wired remote controller installation	56
8.1. Wired Remote Control (Optional part)	17	11 INSTALLATION & SERVICING AIR CONDITIONER	63
9 OPERATION CONTROL	24	11.1. Outline	63
9.1. Operation Mode	24	11.2. Tools for installing/servicing refrigerant piping	64
9.2. Compressor Start Control	24	11.3. Refrigerant piping work	68
9.3. Cooling Operation	24	11.4. Installation, transferring, servicing	70
9.4. Heating Mode Operation	27	12 TROUBLE SHOOTING GUIDE	74
9.5. Louver Control	30	12.1. Self-diagnosis	74
9.6. Odour Removing Operation	32	13 REPLACEMENT PARTS	76
9.7. Energy Save Operation	33	13.1. INDOOR UNIT	76
9.8. Outdoor Fan Remaining Heat Removal Control	33	13.2. OUTDOOR UNIT	78
9.9. Crank Case Heater Control	33	14 ELECTRONIC CIRCUIT DIAGRAM	82
9.10. Valve Error	33	14.1. Indoor unit	82
9.11. Pump Down Operation	34	14.2. Outdoor unit	86
9.12. Indoor Air Volume Up Control (DC Fan Motor Type Only)	34	14.3. Wired remote control	91
		14.4. Print pattern	92

1 SERVICE INFORMATION

Notice of Address setting for NEW Duct / NEW Outdoor Unit.

The new Duct Type / New Outdoor models are possible to have address setting for twin control by automatic when main power supply is switched on.

(Manual address setting is also possible by using Dip switch on Indoor unit P.C. board.) However, **this address setting is only possible when made proper wiring connection and also Indoor unit should be original virgin unit.**

1.1. Example of trouble at test operation

If found out as following phenomenon at test operation on site, it may have possibility of wrong address setting. Therefore, please ensure of the address setting.

1. LCD display of wired remote control had not illuminate although the main power supply switch is 'on'.
2. LCD display had indicated as normal illumination when power supply switch is 'on', however outdoor unit cannot be operated. (But, it is necessary to take 3 to 5 minutes for outdoor unit to start from the timing of remote control ON/OFF switch is 'on'.)
3. P.C. board had memorized wrong setting information.
 - a. If main power supply is switched 'on' with the wrong connection.
 - b. When changing the connection or combination of units due to re-installation etc.
 - When changing the system from twin control to normal one to one system.
 - When making the replacement of units as master and slave etc.

1.2. Caution of test operation

Do not touch the remote control switch and do not change any wirings for one minute when the main power supply switch is 'on'. (Because the unit is having automatic address setting during the first one minute.)

1.3. Caution during automatic address setting

When main power supply switch is 'on', the P.C. board will automatically memorized the connecting system. Consequently, when initial power supply is 'on', there will not be interchangeability of units even of the same type and same capacity unit. Therefore unable to connect the unit to another system.

1.4. Operation Range

The applicable voltage range for each unit is given in "the following table". The working voltage among the three phases must be balanced within 3% deviation from each voltage at the compressor terminals. The starting voltage must be higher than 85% of the rated voltage.

1.4.1. Power Supply

Model CU-	Unit Main Power		Applicable Voltage	
	Phase, Volts	Hz	Maximum	Minimum
L34DBE5 L43DBE5	1~220	50	242	198
	1~230	50	253	207
	1~240	50	264	216
L50DBE8	3N~380	50	418	342
	3N~400	50	440	360
	3N~415	50	457	374

1.4.2. Indoor and Outdoor Temperature

Model 50Hz ... L34DBE5, L43DBE5, L50DBE8

Operating	Hz	Indoor Temp. (D.B./W.B.) (°C)		Outdoor Temp. (D.B./W.B.) (°C)	
		Maximum	Minimum	Maximum	Minimum
Cooling	50	32/23	21/15	43/-	-15/-
Heating	50	27/-	16/-	24/18	-20/-

2 FEATURES

2.1. Variety of excellent features

2.1.1. Compact design, height 36 cm

- The height has been reduced to 36 cm, the equipment can be installed in limited spaces.

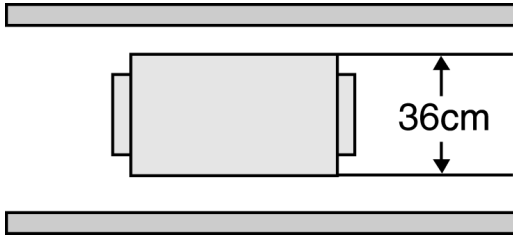

2.1.2. Versatile installation

- The indoor unit is designed in order that air will also enter from below, for easier installation under different conditions.

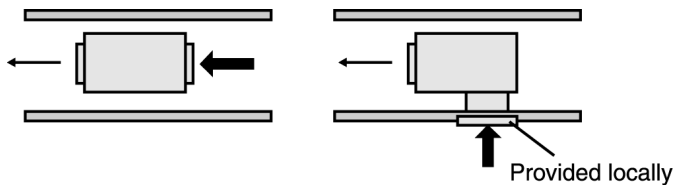

- The equipment has two drain outlets on the right and left side for adoption to the installation conditions in the building.

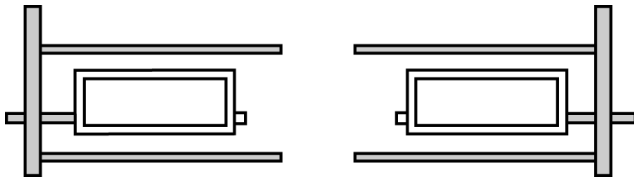

2.1.3. Easy maintenance

- Equipped with a filter as standard. The filter can be removed in three directions for easier maintenance.

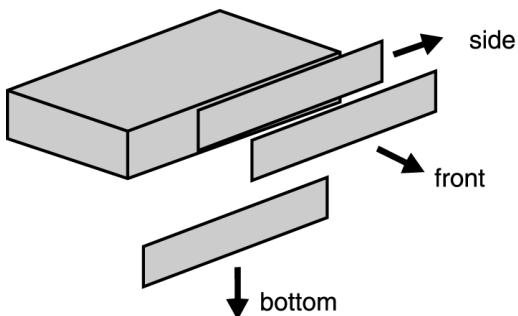

2.1.4. Static pressure selection

- The static pressure is selectable; 5mmAq or 7mmAq. The static pressure can be selected according to the condition of the duct.

2.1.5. Quiet operation

- The sound level is as low as 45db (A) for 6 HP. The models is ideal for installation in offices, shop and houses where quiet operation is important.

2.1.6. Auto fan mode operation (indoor unit)

- Auto fan mode is added to existing modes Hi, Me and Lo. It automatically adjusts the fan speed according to the indoor temperature.

2.1.7. Dry mode function

- Dry mode can make a comfortable indoor environment during wet season.

2.1.8. Automatic changeover function (heat pump models)

- The unit automatically switches between cooling and heating in accordance with operating load in order to maintain a comfortable indoor temperature.

2.1.9. Common design for Indoor unit and Remote Control

- The indoor unit and the wired remote control are design as a common specification between Cooling only and Heat Pump models.

2.1.10. Wired Remote Control



- The new design includes an easily-visible red pilot lamp. The power can be turned on and off at a single touch, without opening the cover.
- A built-in thermistor, allowing indoor temperature detection in accordance with indoor conditions by switching with main unit thermistor.
- Twin non-polar wires make installation work easy (10 m cable supplied as accessories).

2.2. New low-noise outdoor units

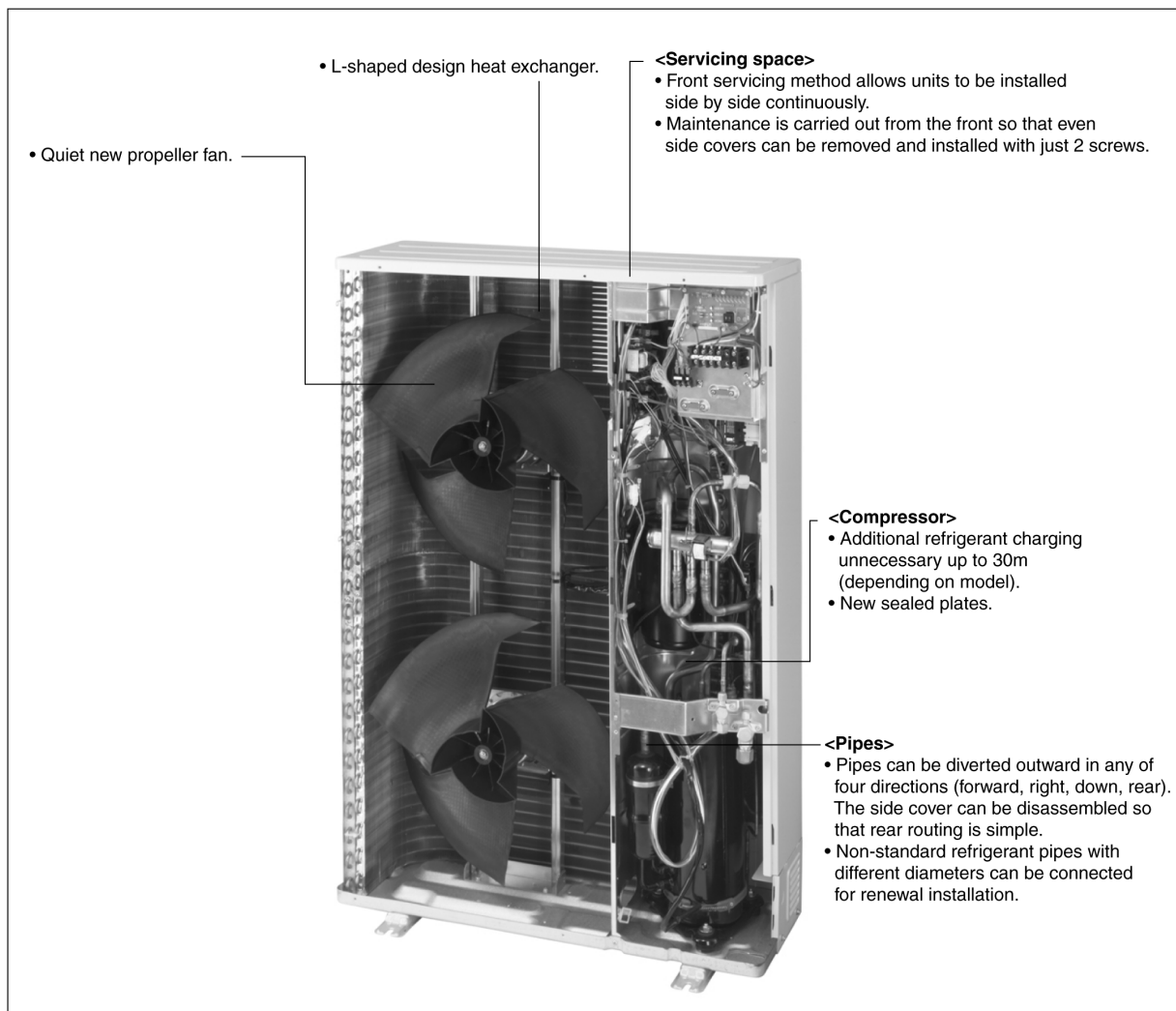

[Product features]

2.2.1. Low-noise design improves in surrounding areas

1. The noise-suppressing winglet fan is a result of new research into vane design theory. The unique curved shape suppresses the generation of vortices, thus reduces air flow noise.

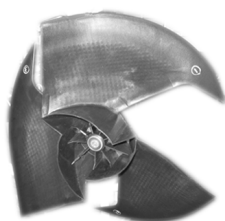

2. The adoption of double-orifice rings reduces air passage resistance.
3. Strengthening of the noise insulation materials in the compressor and the sealing-in of mechanical noise allows vibration noise to be greatly enclosed and suppressed.
4. The heat exchanger has an L-shaped design to allow air to flow more smoothly.
5. Noise is automatically reduced further during night time operation with lower outdoor air temperatures.

2.2.2. Automatic restart function

When the electric power resumes after a power failure, the unit will automatically restarts the operation in the pre-failure mode.

2.2.3. Low ambient cooling operation

Cooling operation is possible at outdoor temperature of -5°C .

2.3. Greatly improved workability increases system renewal capability

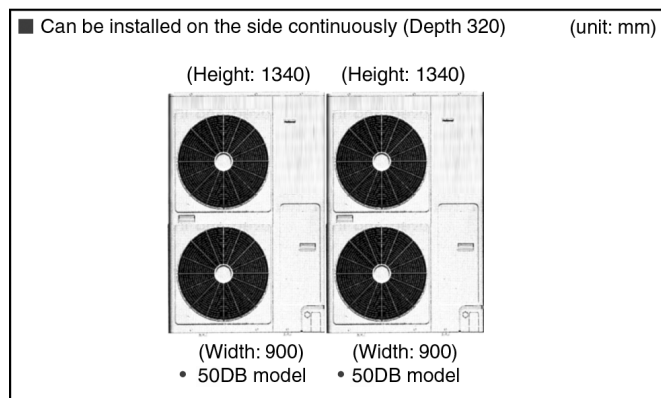

2.3.1. Pipes that are one size larger can also be connected for renewal

- If renewing the system, existing refrigerant pipes can be utilized so that only the indoor units and outdoor units need to be replaced.

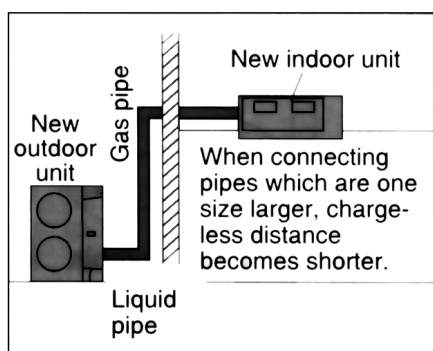

- For example, liquid and gas pipes from 10 years ago can be connected to current pipes with the same size for one size larger. Effective utilization of materials reduces working time and trouble. (Adaptor sockets are not supplied.)

2.3.2. Additional refrigerant charging unnecessary for 30 m

- All models do not require any additional charging of refrigerant for 30 m of pipe length. This makes installation much easier.

2.3.3. Drain water dripping-prevention structure

- The base of the outdoor unit is provided with a single drain hole in order to prevent drain water from leaking out of the unit. Body connecting a drain elbow and a discharge pipe, water leakages can be prevented even when the unit is installed against a wall.

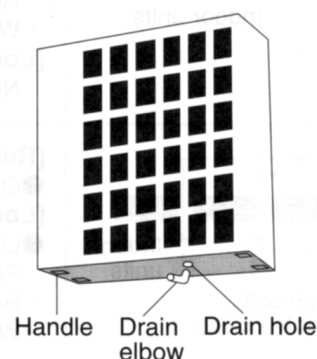

2.3.4. Space saving design allows units to be installed side by side continuously

- Servicing after installation can be carried out by removing the front covers.

2.3.5. Easy test operation

- Test operation can be carried out for both indoor and outdoor units.

2.3.6. Long pipe design

- Maximum piping length of 50 m.

2.3.7. Internal pipe connection

- Pipes are connected inside the units (inside the side covers), making the final appearance more attractive.
- Pipes can be diverted outward in any of four directions (forward, right, down, rear).
- Small liquid pipe diameters of 9.52mm, making installation work much easier.

2.3.8. Centralized draining method

- Even when multiple outdoor units are installed to a wall, the drain outlets can be concentrated into a single drain pipe. This makes installation easier and also improve appearance.

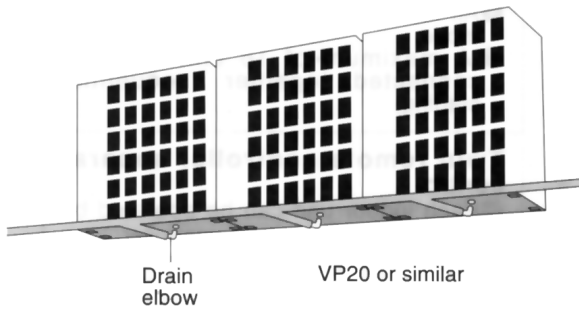

2.4. A brand-new control method using the latest in technology

2.4.1. Power supply wiring is also easier

Power supply wiring and other wiring tasks can be carried out more easily.

- Twin non-polar wires used to connect indoor and outdoor units.
- Adoption of connection error prevention circuits for drives

2.4.4. Group control equipment

Wired remote control	<p>Group control by one remote control</p> <ul style="list-style-type: none"> ● All air conditioner units are controlled as a whole by remote control. ● All indoor units operate in the same mode. ● A maximum of 16 units can be connected together (sequential starting) 	
	<p>Twin remote control separate control</p> <ul style="list-style-type: none"> ● Each indoor unit can be operated by either one of the two remote control. ● Apart from timer setting time, displays for two remote control are identical. ● Last button pressed has priority (main or slave is set at remote control unit). 	

2.4.5. Twin operation

- Simultaneous air conditioning of wide spaces and corners is possible. Indoor units of same horsepowers and models can even be used in combination.
- Master unit and slave-units can be set automatically in twin systems. No address setting is necessary.
- Multiple indoor units can be operated simultaneously with a single remote control. Note that individual operation is not possible.

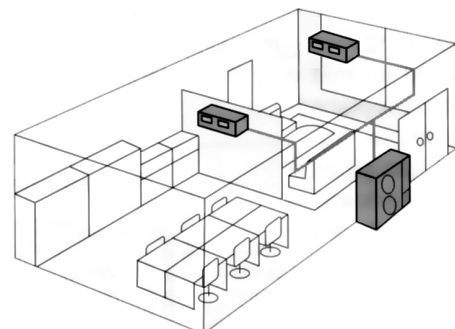

wires and signal wires. If a connection error is made, the relay does not operate and current does not flow to the circuit boards.

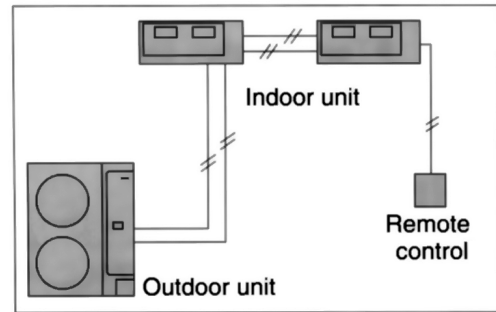

2.4.2. Separate indoor/outdoor unit power supplies



The power supply can be connected to (1) just the outdoor units, or (2) to both indoor and outdoor units.

2.4.3. Automatic setting initialization function (Remote control and Indoor unit)

In accordance with the indoor and outdoor units connected and the connection methods, conditions such as the configuration (twin or triple format) and remote-control functions such as cooling only or heat pump model are automatically detected and set instantly.

■ Twin combination table

Outdoor unit	Simultaneous twin operation	
	Standard	
3.0 HP	3.0	1.5 1.5
4.0 HP	4.0	2.0 2.0
5.0 HP	5.0	2.5 2.5
6.0 HP	6.0	3.0 3.0

 : Outdoor unit capacity
 : Indoor unit capacity

3 SPECIFICATION

3.1. CS-F50DD2E5 CU-L50DBE8

ITEM / MODEL			Main Body	Indoor Unit	Outdoor Unit
				CS-F50DD2E5	CU-L50DBE8
Cooling Capacity			kW	14.0	
			BTU/h	47,700	
Heating Capacity			kW	16.0	
			BTU/h	54,600	
Refrigerant Charge-less			m	30	
Standard Air Volume for High Speed			m ³ /min	Cooling; 30, Heating; 38	-
			cfm	Cooling; 1059, Heating; 1342	-
External Static Pressure			Pa	Hi 98	-
			mmAq	Hi 10.0	-
Outside Dimension (H x W x D)			mm	360 x 1000 x 650	1340 x 900 x 320
			inch	14-3/16 x 39-3/8 x 25-19/32	52-7/8 x 35-7/16 x 12-19/32
Net Weight			kg (lbs)	48 (106)	105 (231)
Piping Connection	Refrigerant	Gas	mm (inch)	O.D Ø 15.88 (5/8) Flared Type	
		Liquid	mm (inch)	O.D Ø 9.53 (3/8) Flared Type	
	Drain		mm	Female screw RC1 (PT1)	I.D Ø 20 x 1
Compressor	Type, Number of Set			-	Hermetic - 1 (Rotary), 1
	Starting Method			-	Direct on-line starting
	Motor	Type		-	4-pole single phase brushless motor
Rated Output		kW		-	3.8
Fan	Type, Number of Set			Sirocco Fan	Propeller fan-1
	Motor	Type		4-pole single phase induction motor	6-pole single phase induction motor
		Rated Output	kW		0.27
Air-heat Exchanger (Row x Stage x FPI)				Slit-fin type (2 x 10 x 20)	Louvre-fin type (2 x 36 x 19)
Refrigerant Control				Capillary tube	-
Refrigerant Oil (Charged)			cm ³	-	FV50S (1200)
Refrigerant (Charged) R410A			kg (oz)	-	3.50 (123)
Running Adjustment	Control Switch			Wired Remote Control	-
	Room Temperature			Thermostat	-
Safety Devices				Internal protector for compressor, Internal thermostat for fan motor, Crankcase heater, High pressure switch, Current transformer	
Noise Level			dB (A)	Cooling : Hi 49 Lo 45 Heating : Hi 47 Lo 44	Cooling 54, Heating 56
			Power level dB	Cooling : Hi 64 Lo 60 Heating : Hi 62 Lo 59	Cooling 68, Heating 70
Moisture Removal			L/h	9.0	
EER			W/W	2.77	
COP			W/W	3.30	

1. Cooling capacities are based on indoor temperature of 27°C D.B. (80.6°F D.B.), 19.0°C W.B. (66.2°F W.B.) and outdoor air temperature of 35°C D.B. (95°F D.B.), 24°C W.B. (75.2°F W.B.)

2. Heating capacities are based on indoor temperature of 20°C D.B. (68°F D.B.) and outdoor air temperature of 7°C D.B. (44.6°F D.B.), 6°C W.B. (42.8°F W.B.)

ELECTRICAL DATA (50 Hz)

ITEM / MODEL			Condition by JIS-B8615		
Volts	V		380	400	415
Phase			3N	3N	3N
Power Consumption	kW	Cool	5.06	5.06	5.06
		Heat	4.85	4.85	4.85
Running Current	A	Cool	8.0	7.7	7.4
		Heat	7.7	7.4	7.2
Starting Current	A		8.0	7.7	7.4
Power Factor	%	Cool	96	95	95
		Heat	96	95	94
*Power Factor means total figure of compressor, indoor fan motor and outdoor fan motor.					
Panasonic		Power source		AC, 3N~380V, 400V, 415V 50Hz	

4 DIMENSIONS

4.1. CS-F50DD2E5

NO.	NAME	QTY	NOTE
1	Pipe connection (gas)	1	O. D. $\phi 15.08$ Flared
2	Pipe connection (liquid)	1	O. D. $\phi 9.52$ Flared
3	Drain pipe connection	2	O. D. $\phi 32$
4	Duct connection	2	
5	Hanger	4	
6	Control box	1	

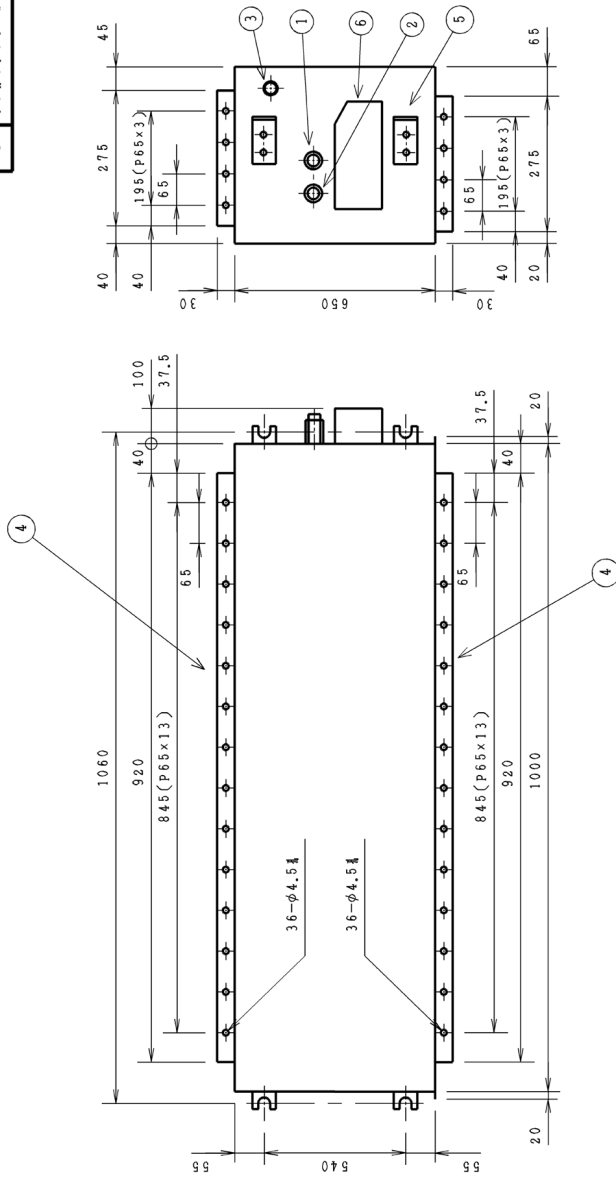

UNIT : mm

Outside Dimensions	MODEL NO.	CS-F88DD1E5 CS-F44DD2E5 CS-F43DD2E5 CS-F50DD2E5
--------------------	-----------	--

4.2. CU-L50DBE8

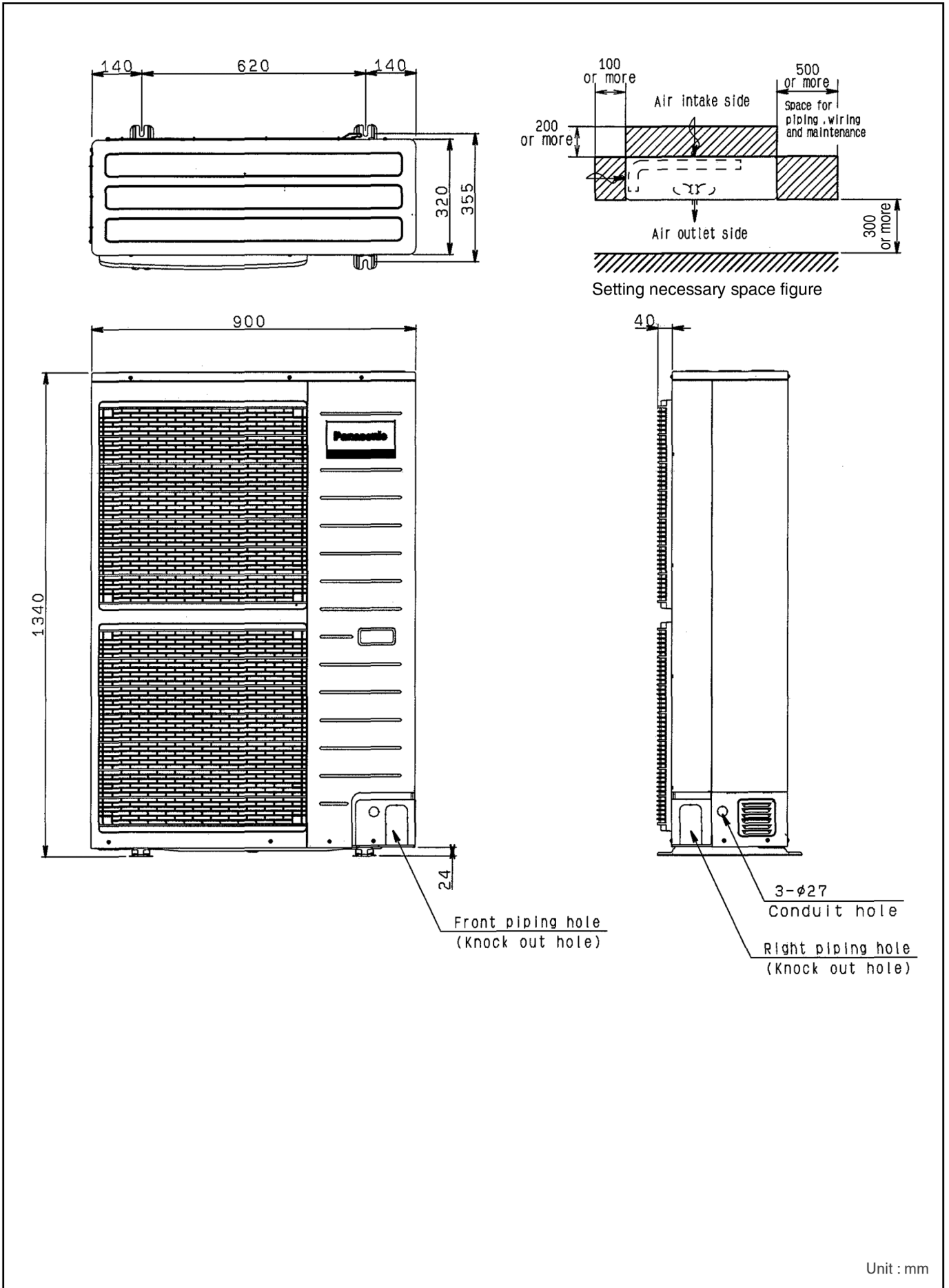

Unit : mm

5 REFRIGERATION CYCLE

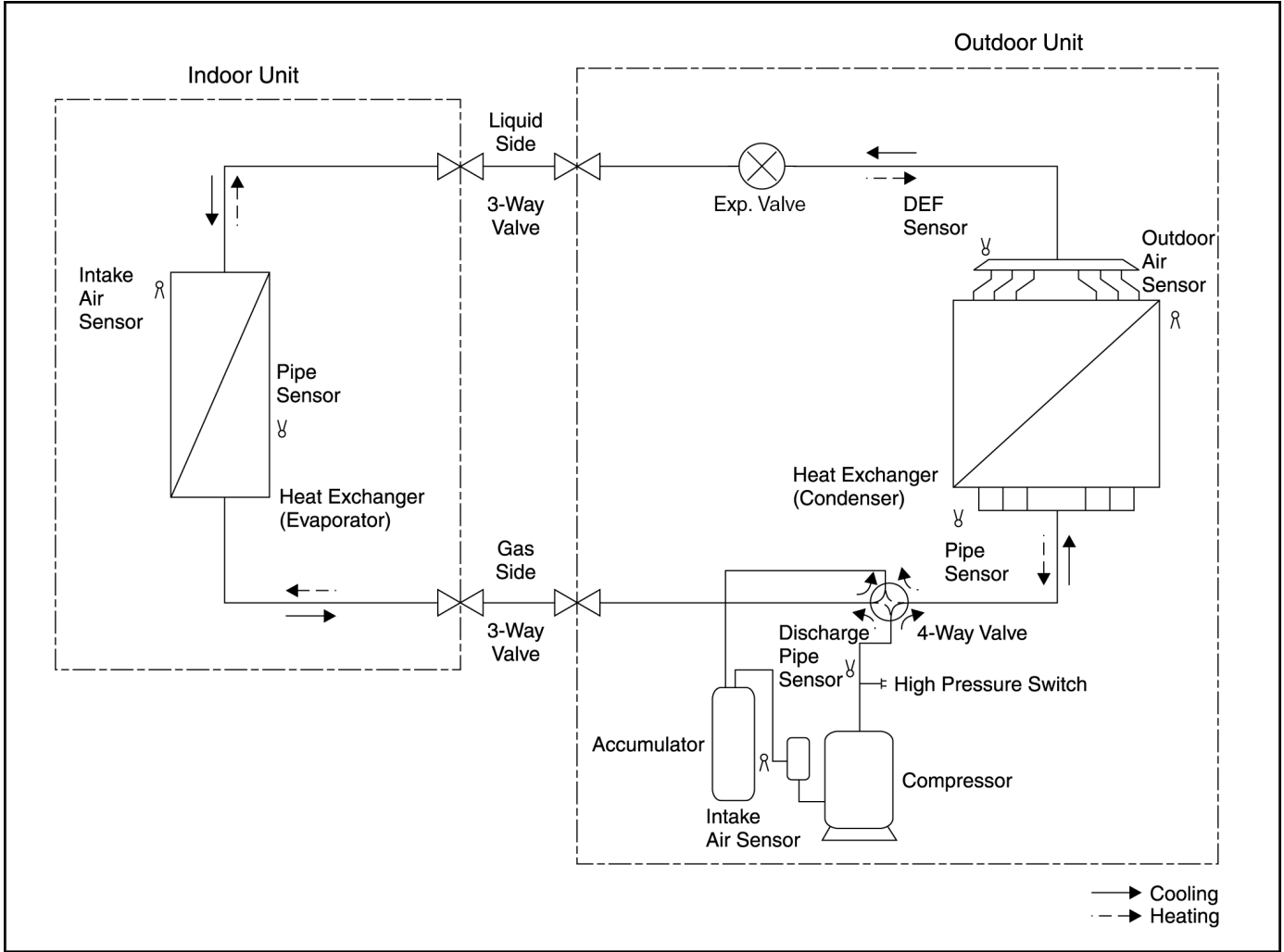

6 BLOCK DIAGRAM

6.1. CS-F50DD2E5

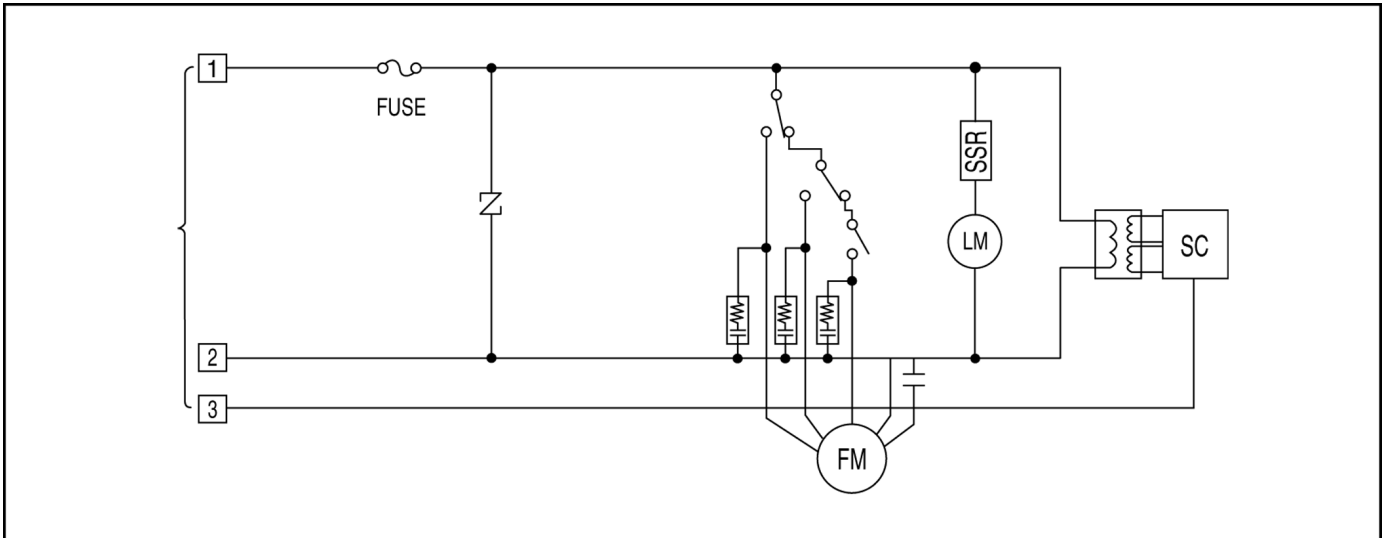

6.2. CU-L50DBE8

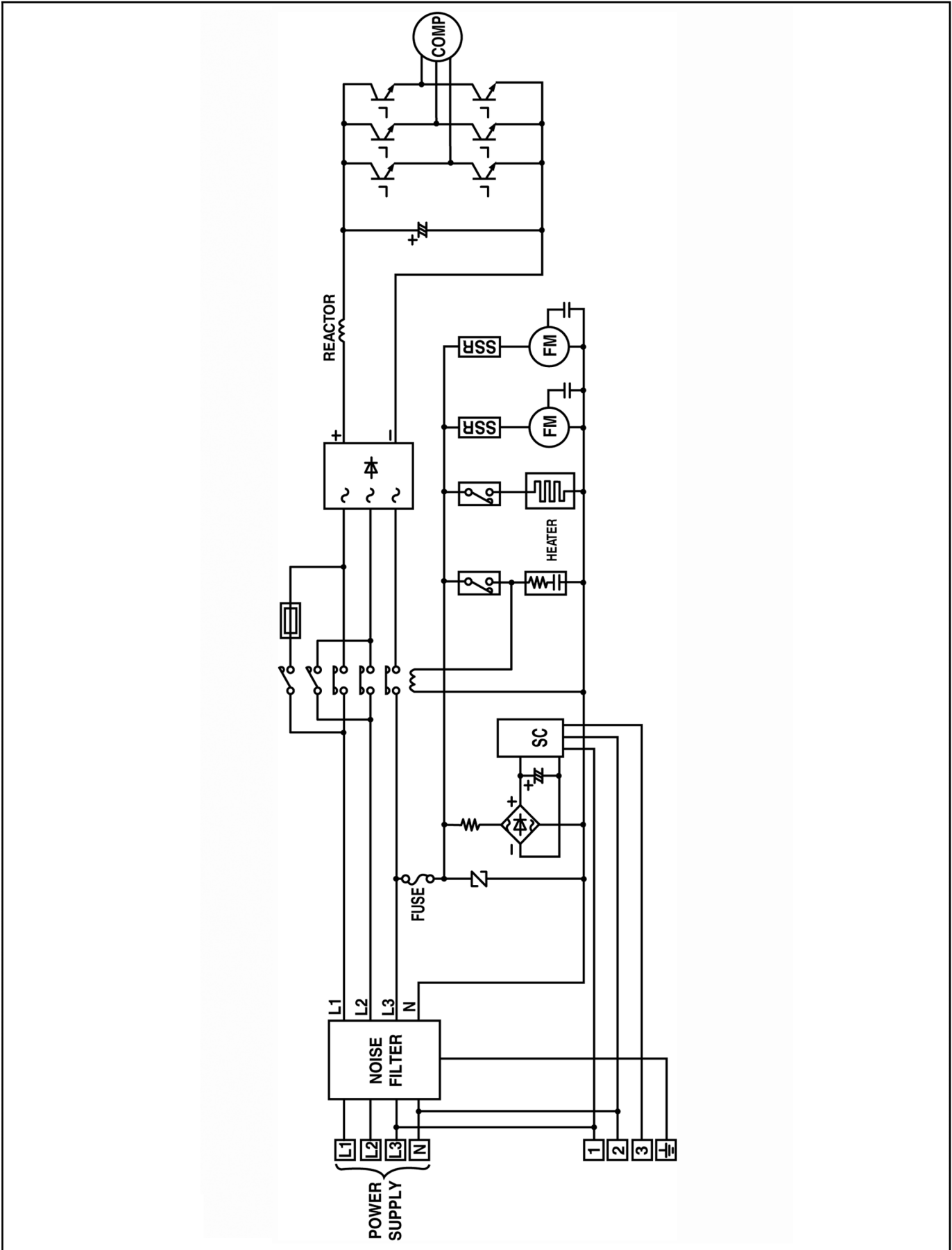

7 WIRING DIAGRAM

7.1. CS-F50DD2E5

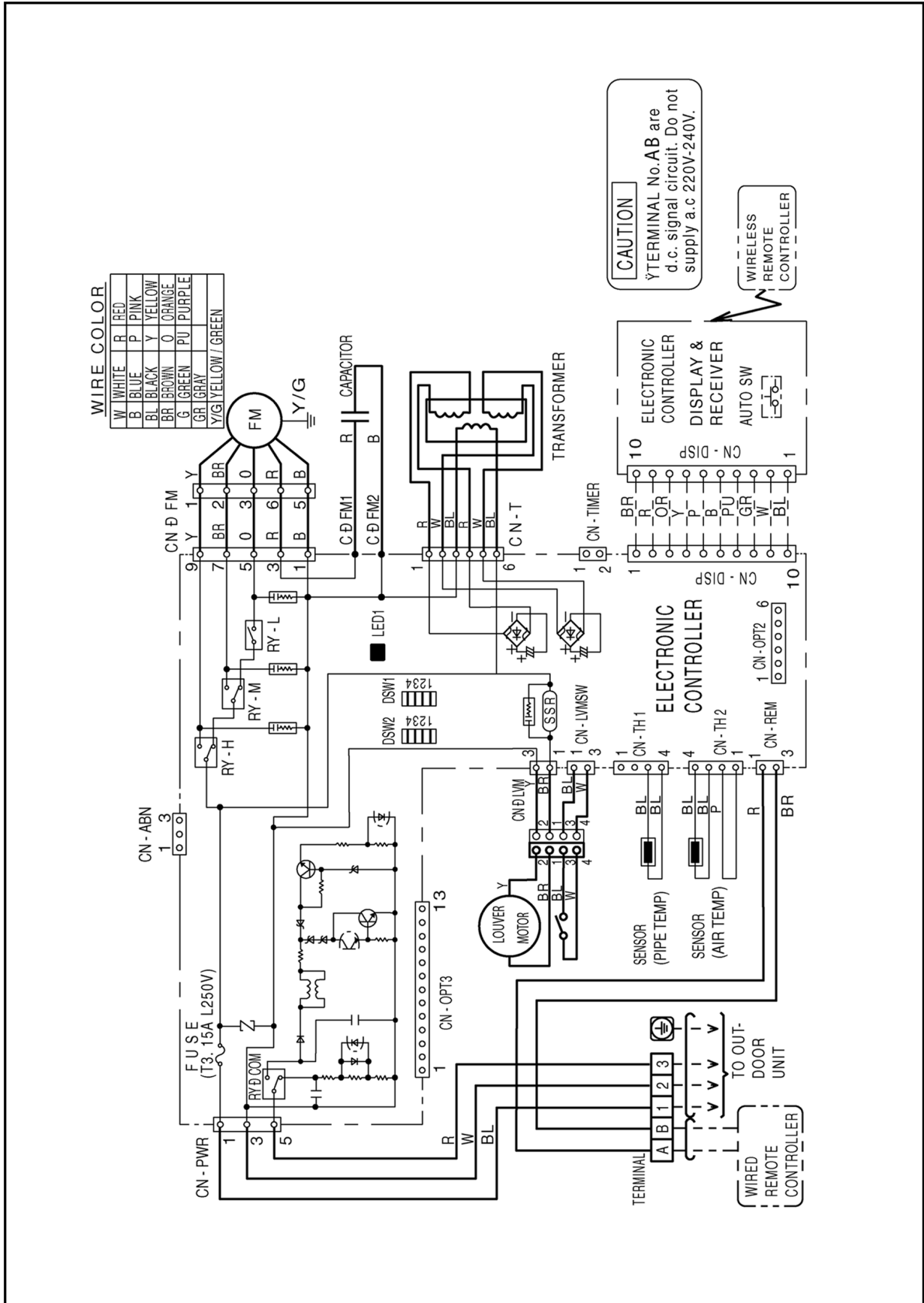

7.2. CU-L50DBE8

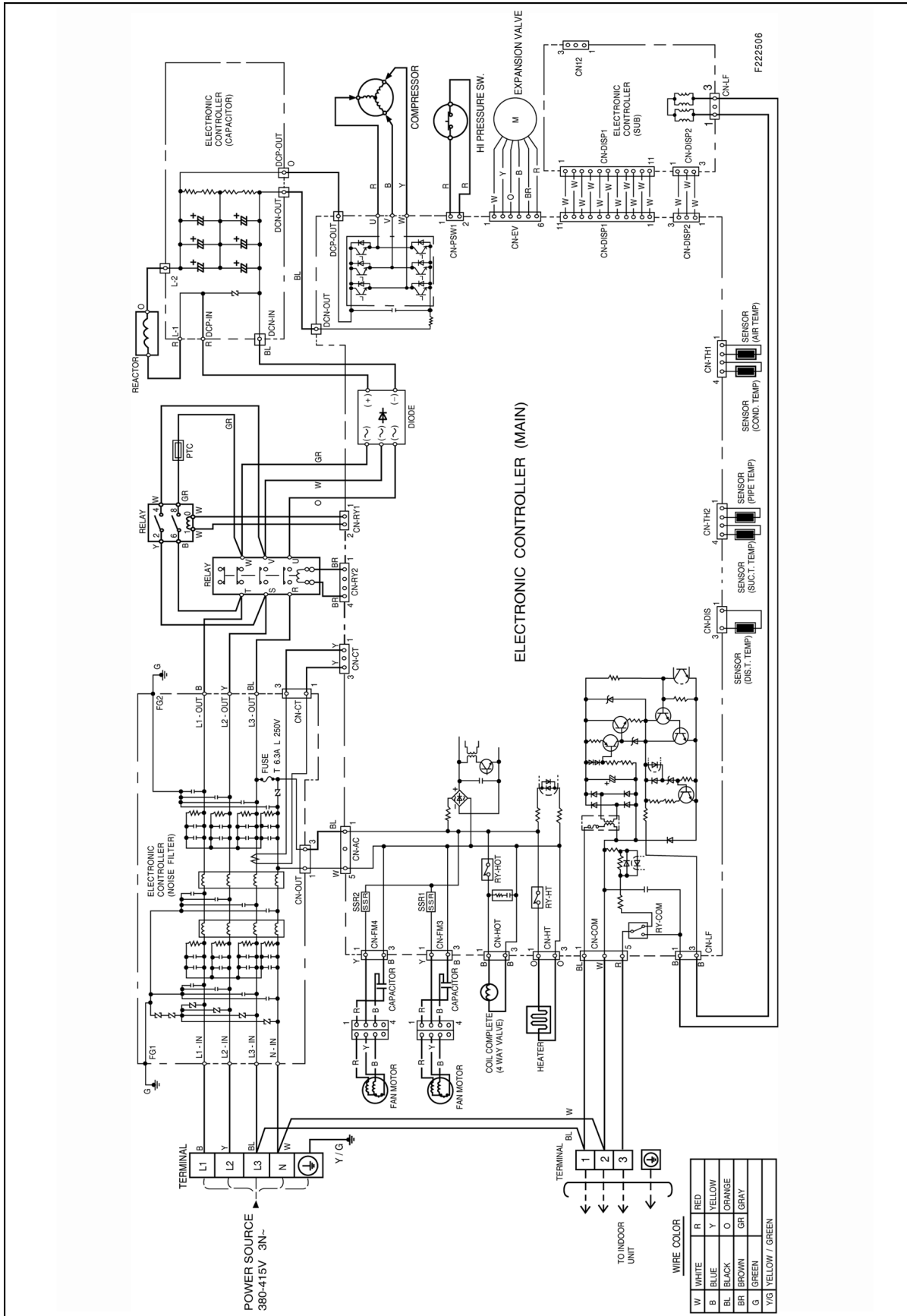

8 OPERATION DETAILS

8.1. Wired Remote Control (Optional part)

8.1.1. Name and function of each part

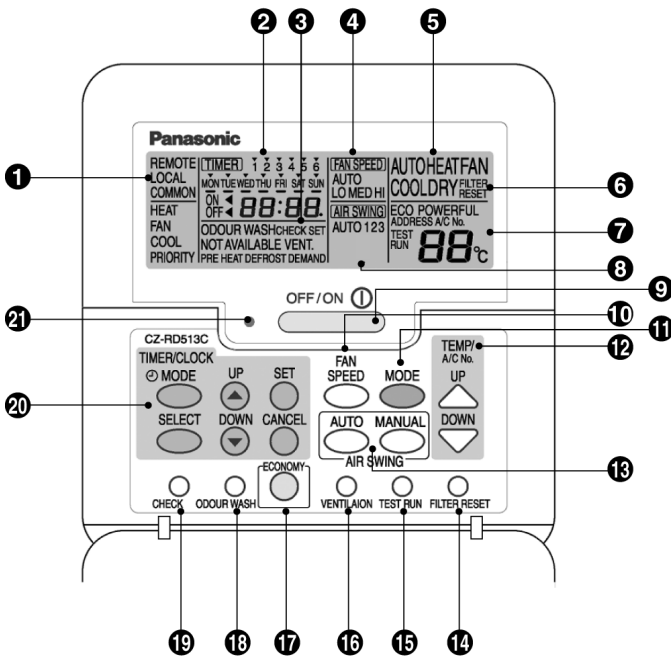

- 1 REMOTE**
The OFF/ON button cannot be used.
LOCAL
All wired remote control buttons can be used.
- 2 Time/time setting display**
- 3 Check display**
- 4 Fan speed display**
- 5 Operation mode selection display**
- 6 FILTER RESET display**
(Appears after the cumulative running time reaches approximately 2,500 hours of operation.)
- 7 Temperature setting display (16°C - 31°C)**
- 8 Airflow direction setting display**

- 9 OFF/ON button**
Used to start and stop the operation.
- 10 FAN SPEED button**
Used to select the fan speed of high (HI), medium (MED), low (LO) or auto (AUTO).
- 11 MODE button**
Used to select the operation of AUTO, HEAT, FAN, COOL, or DRY.
- 12 TEMP (UP/DOWN) buttons**
Used to select the desired temperature.
- 13 AIR SWING (AUTO/MANUAL) buttons •**
Used to determined the air swing condition, either auto or manual.
- 14 FILTER RESET button**
Press to reset the "FILTER RESET" display after washing the filter.
- 15 TEST RUN button***
- 16 VENTILATION button***
- 17 ECONOMY operation button**
Provides Energy saving function
- 18 ODOUR WASH button**
Provides deodorizing function.
- 19 CHECK button**
Press this button if the check display is flashing.
- 20 TIMER/CLOCK SET buttons**
Used to set the timer operation and the current time.
- 21 Operation indicator**
Lights up when the unit in operation.

NOTES

- Ensure that the correct button is pressed as simultaneous pressing of the multiple buttons will not make the setting correct.
- The illustration above is for explanatory purposes only. The appearance will be different during actual operation.
- Do not operate the remote control with wet hands. Otherwise, electric shock or malfunction may occur.
- Do not press the remote control buttons with sharp object as this may damage the remote control.
- Buttons marked with * are not needed for normal operation. If one of these buttons is pressed by mistake, press the same button once more to cancel the operation.
- When the power resumed after power failure, the unit will restart automatically with all the previous settings preserved by the memory function. (Auto restart function)
- Buttons marked with • are not available for operation. If one of these buttons is pressed function will not be available.

8.1.2. Remote Control - Display

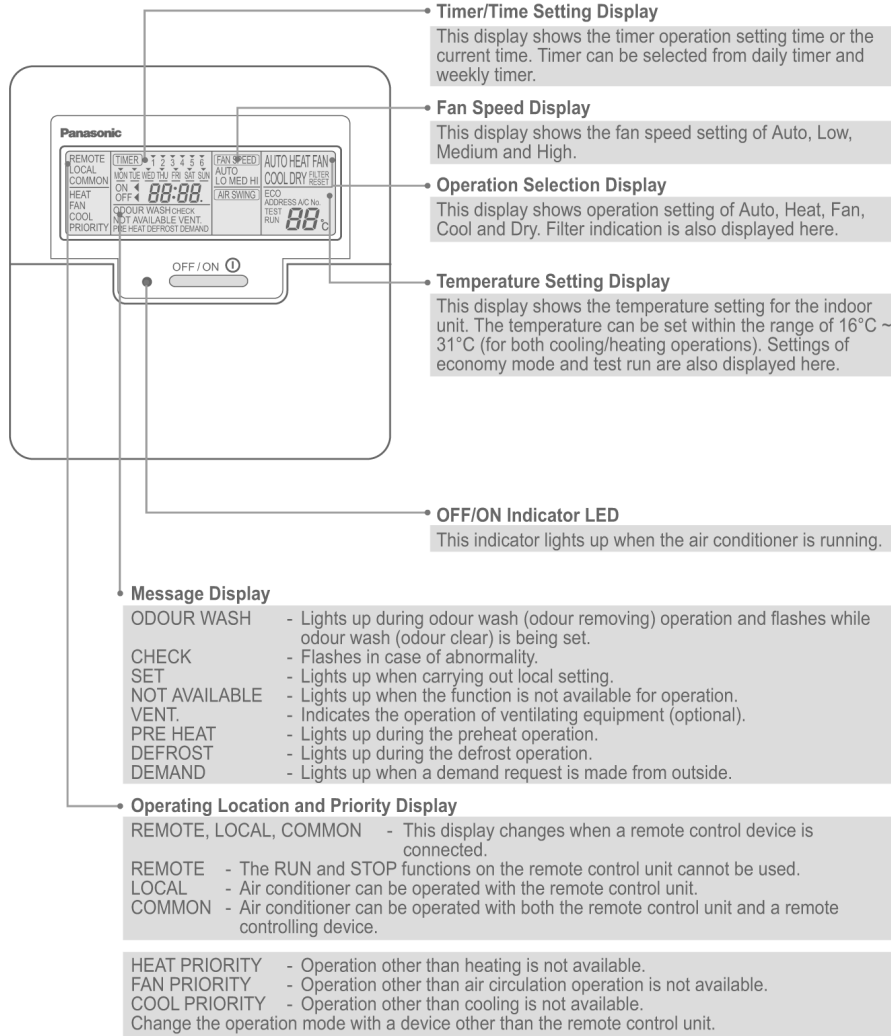

8.1.3. Remote Control - Panel

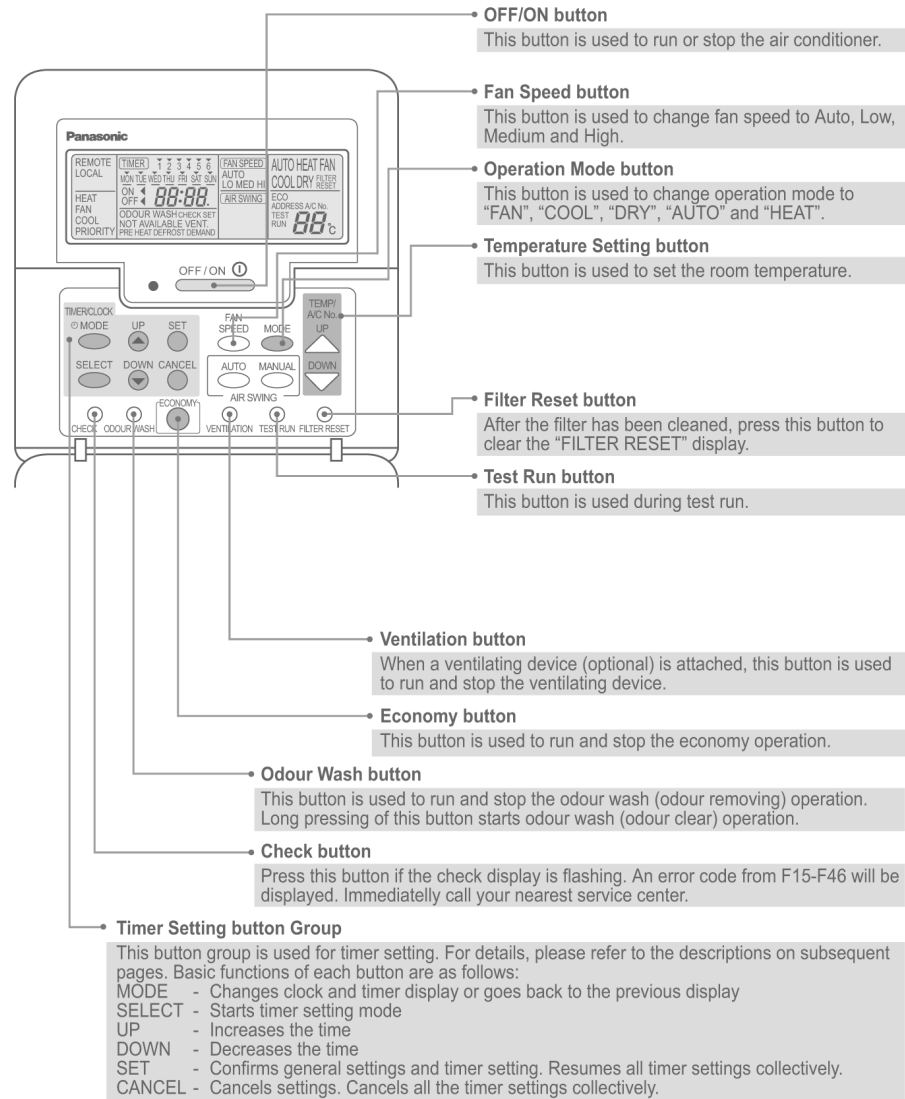

8.1.4. Setting Current Time

- The current time needs to be set when you turn on the power for the first time or after a long time has elapsed since the power was last turned on.
- The current time becomes the standard time for all the Timer operations.
- Set the current time and day accurately.
- Example : Current Day is Wednesday and Current Time is 8:00.

1 Turn on the power supply

2 Press "SELECT button"

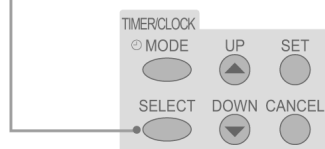

Below displays will appear

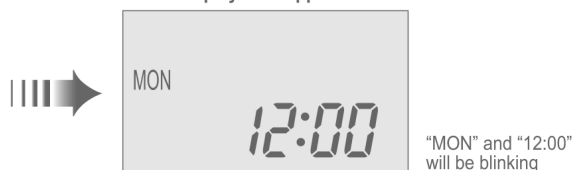

3 Select Current Day

To set the current day, press "UP or DOWN button" to select current day.
(Refer to above example; select WED)
To confirm the selected day, press "SET button".

4 Select Current Time

To set the current time, press "UP or DOWN button" to select current time.
(Refer to above example; select 8:00)
To confirm the selected time, press "SET button".

Note:

- Press "UP button" to increase or "DOWN button" to decrease (interval 1 minute) or hold the button to change the time faster.
- If the "UP or DOWN button" is not pressed for 30 seconds during the day or time setting or if the "SELECT button" is pressed, the setting at that moment is confirmed and setting will end.

Final CLOCK Display

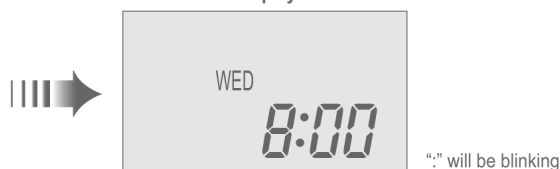

8.1.5. How To Select The Timer

- 2 types of Timer mode can be selected on the remote control.
 - Daily Timer
 - Weekly Timer
- These timers cannot be operated simultaneously.
- Select one of these Timers for your convenience.

How to Change the Display



- Press once to change the display from CLOCK to Timer or vice-versa.
- Press more than 3 seconds to change the display from Daily Timer to Weekly Timer or vice-versa.

CLOCK Display (To set current Day and Time)

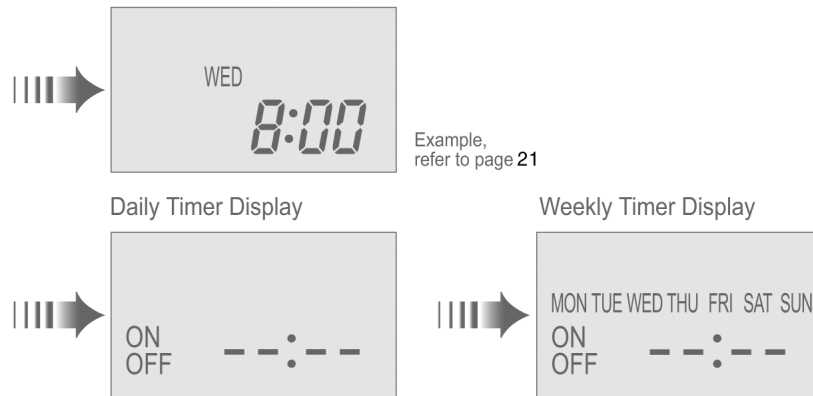

Note:

- The above display is shown if no valid timer setting is made.
- If valid timer setting is made.
 - **Timer** and setting will be displayed.
 - If you want to check the current time and day, press “MODE button” once.
(However, after a few seconds, the display will change back to **Timer** and the setting)

8.1.6. Daily Timer Setting

• Display

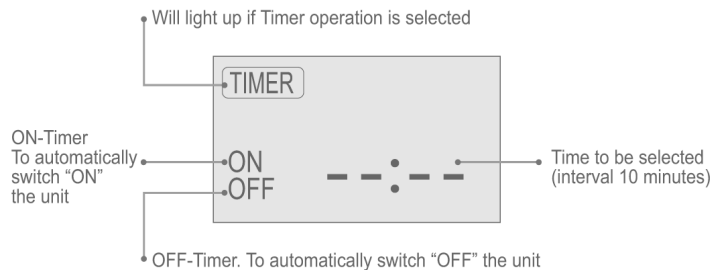

• How to Set Daily Timer

- You can set only “ON” or only “OFF” or “ON” and “OFF” in a day.

1. Change Display

Press “MODE button” to change the display to daily timer.



2. ON-Timer, OFF-Timer and select Time

Press “SELECT button”; ON-Timer setting will be displayed.

Press “UP or DOWN button” to select the desired time, (Example: ON 9:00), then press “SET button” to confirm the selected desired time.

Or press “CANCEL button” if you do not want any setting for ON-Timer.

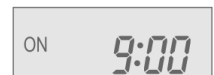

Then OFF-Timer setting will be displayed.

Press “UP or DOWN button” to select the desired time, (Example: OFF 18:30), then press “SET button” to confirm the selected desired time.

Or press “CANCEL button” if you do not want any setting for OFF-Timer.

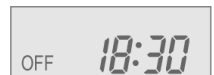

Note:

- The setting timer will be activated everyday.
- Timer nearer to the current time will be activated first.

Final Display of Daily Timer:



Only ON-Timer being selected. The Unit will automatically switch ON at 9:00.



Only OFF-Timer being selected. The Unit will automatically switch OFF at 18:30.



ON and OFF Timer are selected. ON-Timer will be activated first due to 9:00 being nearer to current time.

8.1.7. Weekly Timer Setting

• Display

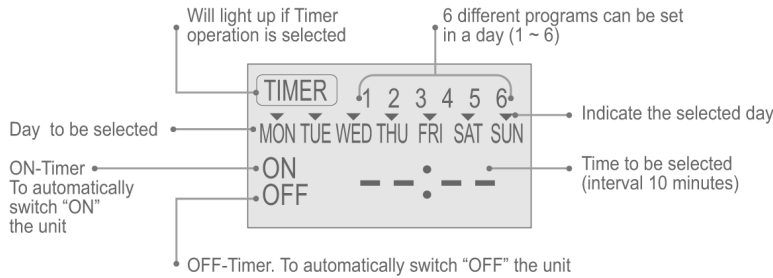

• How to Set Weekly Timer

- You can set the Timer for 1 week (Monday to Sunday) with 6 programs per day.
- ON-Timer can be set together with your desired temperature. However, this temperature will be used continuously.
- Cannot set 2 programs with same time setting in a day.
- You also may select Collective - many days with same time setting or Individual - single/one day setting.

1. Change Display

Press "MODE button" to change the display to weekly timer.

2. Select Day (please refer to next page for example of setting)

You may select Collective or Individual day setting.

• Collective day setting.

Press "SELECT button": display will show day selection setting.

Press "UP or DOWN button" to select the day. Then press "SET button" to delete triangle mark (deselect) or add triangle mark (select).

(Triangle mark on top of each day indicates the day to be selected).

Repeat these steps if you want to deselect or select many days.

To confirm the selected days, press the "SELECT button".

• Individual day setting.

Press "UP or DOWN button" to select the day.

Then press "SELECT button".

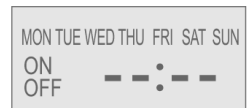
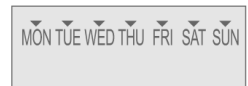

3. Select Time (please refer to next page for example of setting)

For 1st program setting.

Press "UP or DOWN button" to select ON or OFF.

Then press "SET button" to confirm.

Press "UP or DOWN button" again to select the desired time.

(If you want to set them together with your desired temperature, press "TEMP UP/DOWN button" to select the temperature).

Then press "SET button" to confirm.

Or press "CANCEL button" if you do not want to set any time.

For 2nd ~ 6th program you may refer to the above step.

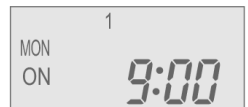

Example: Setting 1st program



For example , if you want to set:

- A - Monday to Friday: Same time, 1st program ON 9:00 & 2nd program OFF 16:00.
- B - Only Wednesday: Additional 3rd program OFF 12:30 & 4th program ON 13:30.
- C - Only Saturday: 1st program ON 10:00 with 20°C & 2nd program OFF 14:00.
- D - Sunday: Holiday. No need to set any Timer.

- To set A (Monday to Friday - Collective day setting)

Press "SELECT button"

To select Monday to Friday, deselect Saturday and Sunday by pressing "UP or DOWN button" to Saturday, press "SET button" (triangle mark on top of Saturday will disappear)

Follow the same step to deselect Sunday.

Ensure triangle mark appears on top of Monday ~ Friday.

- To confirm the selected days, press "SELECT button".

To set the time, please refer to step 3. Select time at page 23.

- 1st program - select ON and desired time to 9:00.
- 2nd program - select OFF and desired time to 16:00.
- 3rd ~ 6th program - press "CANCEL button".



- To set B (Wednesday - Individual day setting)

- Press "UP or DOWN button" to select WED (Wednesday).

Then press "SELECT button".

To set the time, please refer to step 3. Select time at page 23.

- 1st program - press "SET button" twice (confirm ON and 9:00)
- 2nd program - also press "SET button" twice. (Confirm OFF and 16:00)
- 3rd program - select OFF and desired time to 12:30
- 4th program - select ON and desired time to 13:30
- 5th ~6th program - press "CANCEL button"

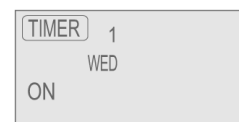
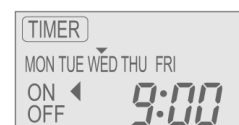

- To set C (Saturday - Individual day setting)

- Follow the same step as above.

To set the time, please refer to step 3. Select time at page 23.

- 1st program - select ON, desired time to 10:00 and desired temperature to 20°C.
- 2nd program - select OFF and desired time to 14:00.
- 3rd ~ 6th program - press "CANCEL button".

- Final Display for Weekly timer may show as:

(Display is showing, 9:00 ON - Timer on Wednesday will be activated next because it is nearest the current day/time.)

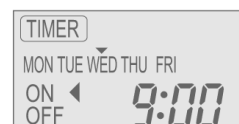
**Note:**

- Timer that has setting nearest to current time and day will be activated first.
- To check the setting timer, press "SELECT button", then "UP or DOWN button" to select day. The display will show each program for the selected day.
- To reset the setting for all, press "SELECT button", then ensure all day setting with triangle mark. Then press "CANCEL button" for all the programs.

9 OPERATION CONTROL

Description of basic control functions

9.1. Operation Mode

1. Thermostat control
2. Depend on differences between room temperature and setting temperature, Compressor running frequency will be decided and start operation.

Temperature differences become same as below table, then thermostat is off.

Temperature Differences

				Unit: °C
Indoor type	Cassette	Ceiling	Duct D2	Duct D3
Cool mode	-1.5	-1.5	-2.0	-2.0
Dry mode	-2.5	-2.5	-3.0	-3.0
Heat mode	3.5	2.5	2.5	2.5

3. Select indoor temperature thermostat

When connected to wired remote controller, either indoor unit thermostat or remote controller thermostat is available, using remote control setting.

9.2. Compressor Start Control

- When the compressor start, compressor frequency will be fixed at lower level for certain time, to follow the below table, due to avoid the compressor oil discharge.
- Judging from compressor discharge temperature, decide the start condition to select either cool start control, or warm start control.

Discharge temp. [°C]	>15°C	15°C ≤
Start control	Cool start	Warm start

Warm start : set 1 → *set 5 → normal control

Cool start : set 1 → set 2 → set 3 → set 4 → *set 5 → normal control

- Note

- Frequency at *set 5 = frequency calculated by normal control
- In case of frequency at set n excess the frequency at set 5 in cool condition, skip from set n to set 4 and transfer to set 5.

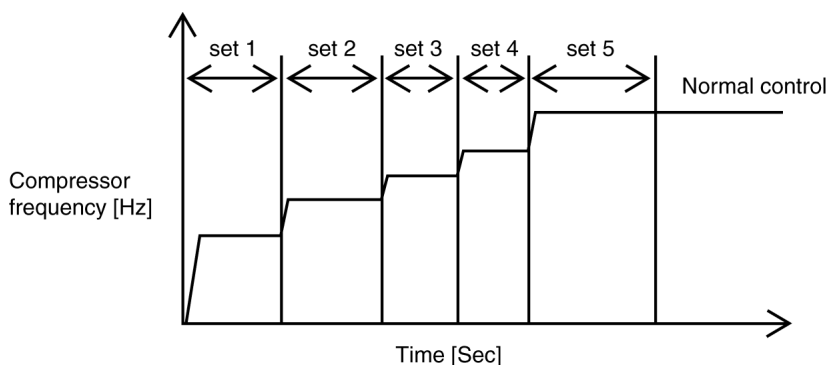

9.3. Cooling Operation

9.3.1. Cool indoor fan control

- Fan speed manual

Common control for unit using DC motor / unit using AC motor.

Operation start at hi speed, or medium speed, or low speed set by remote control.

- Fan speed auto

When operation start, or shifting to thermostat ON condition from thermostat OFF condition, odour cut operation (refer odour cut operation page for detail), after thermostat ON condition, indoor fan operate as below control.

– Unit using DC motor

As follow the below figure, fan speed changing operation (program air).

(rpm center B and α is different if capacity rank is different)

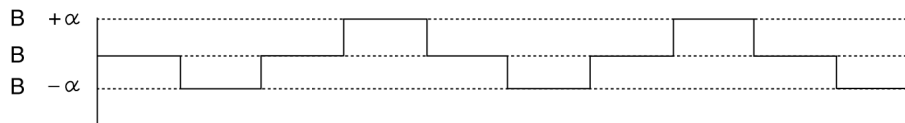

– Unit using AC motor

When 1st thermostat on condition from operation start, fan speed is hi (same as manual fan speed), after 2nd thermostat on condition, fan speed change to medium speed (same as manual medium fan speed).

9.3.2. Odour cut control

- When cool or dry mode operation start, select odour cut mode or fan auto mode, by remote control, operation start at odour wash mode when compressor start or shift to thermostat on from thermostat off.
- Odour cut operation is under below condition.

Operation mode		Cool or dry mode	
Odour wash setting		Setting	No setting
Fan setting	Auto	Odour cut	Odour cut
	Manual	Odour cut	-

- Odour cut operation is to remove the odour generated at indoor heat exchanger to use the drain water come out from indoor heat exchanger.

Thermo & comp ON/OFF			Thermostat ON & comp ON			Thermostat ON			Thermostat ON & comp ON		
Time			40 [Sec]	50 [Sec]	-	20 [Sec]	120 [Sec]	20 [Sec]	40 [Sec]	50 [Sec]	-
Cool	Auto	DC motor	OFF	SSLo	Program air	SSLo	OFF	SSLo	OFF	SSLo	Program air
		AC motor	OFF	Lo	Hi	Lo	OFF	Lo	OFF	Lo	Me
Dry	Auto	DC motor	OFF	SSLo	SLo	SSLo	OFF	SSLo	OFF	SSLo	SLo
		AC motor	OFF	Lo	Lo	Lo	OFF	Lo	OFF	Lo	Lo

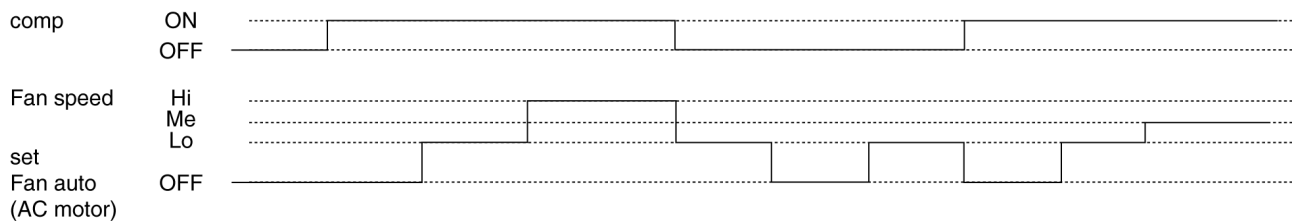

9.3.3. Cool powerful operation

- When cool or dry mode operation start, temperature differences between room temperature and setting temperature is more than 5 K, setting temperature shift to 2 K down.
- (But when temperature after shifting is less than 16°C, setting temperature is 16°C = no change)
- Micro computer judge that required indoor load is bigger than calculation base from temperature differences between room temperature and setting temperature, then increase the compressor frequency compared to normal to cool down indoor side immediately.
- Those kind of operation complete after 30 minutes when cool mode operation start.

9.3.4. Freezing prevention control

- During cool or dry mode operation, if indoor evaporator temperature is going down, freezing prevention control is operated.
- Detail of Freezing prevention control is as follows;

Indoor evaporator temperature area is divided into 5 zones, which consist of stop zone, down zone, no change zone, up zone, and recovery zone. When indoor evaporator temperature is going into each zone, compressor frequency change by following the below table.

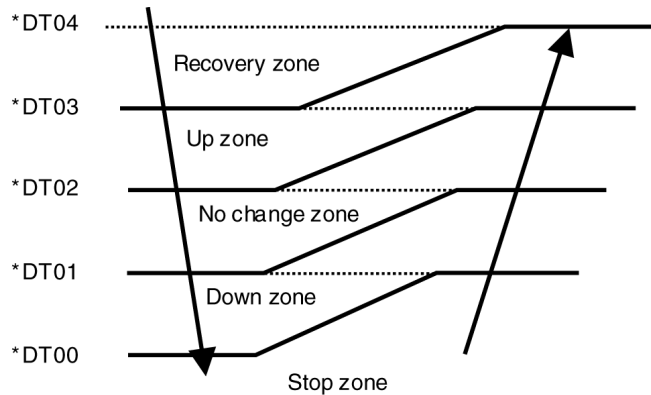

*DTn=indoor piping sensor

Recovery zone	Release freezing prevention operation
Up zone	Fan motor speed step up
No change zone	Operation no change
Down zone	Reduce the compressor frequency (check for 3 min, max 3 times)
Stop zone	If continue for 6 min, compressor stop (for 3 min after stop, compressor can be started due to restart delay control)

9.3.5. Dew form prevention control

- During cool or dry operation, if outdoor temperature is less than 30°C, and indoor fan speed is low or auto setting, indoor heat exchanger temperature become lower, dew form prevention control start to prevention dew form at indoor discharge grill.
- Indoor evaporator temperature area is divided into 4 zones, which consist of, down zone, no change zone, up zone, and recovery zone.
- When indoor evaporator temperature is going into each zone, change compressor frequency and louver angle by following the below table.

Ttuyu n = Indoor piping sensor

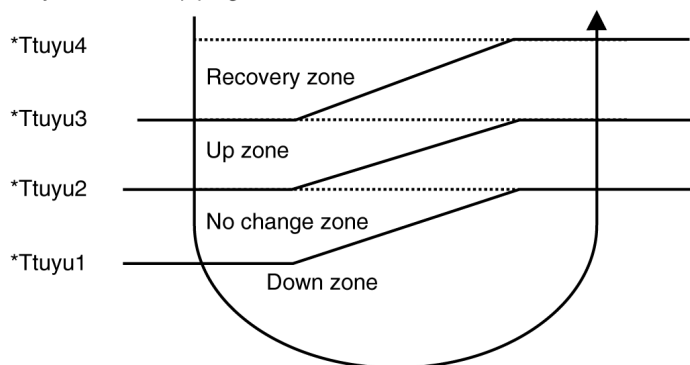

Recovery zone	Release dew form prevention operation
Up zone	Fix the indoor louver angle Cassette type : fix the manual 3rd position Ceiling type : fix the manual 2nd position
No change zone	Continue check the indoor heat excahnger temperature
Down zone	Reduce the compressor frequency (check for 3 min, max 3 times)

9.3.6. Drain pump control

- During cooling, dry, or defrost operation, drain pump operate by following the below table.
- When compressor start, drain pump operation start after 10 second of indoor fan starting.

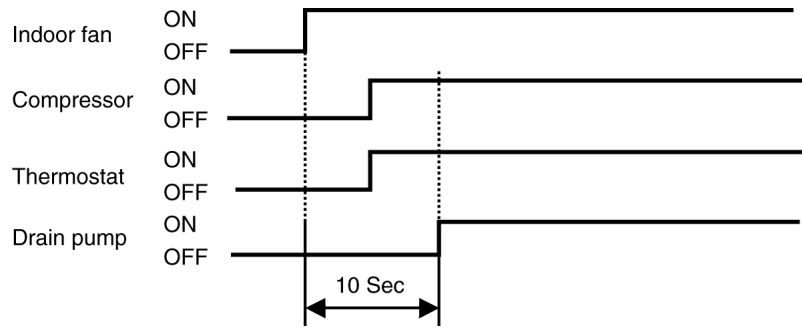

- When operation stop or thermostat is off, drain pump continue operating for 6 minute to prevent the drain water from coming back.

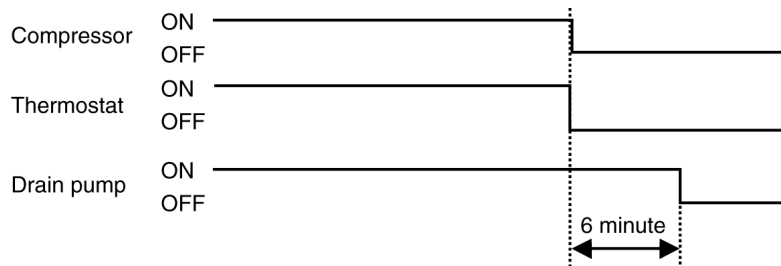

9.3.7. Cooling low temperature protection control

- During cooling, or dry operation, if outdoor temperature is less than -15°C.
 - And thermostat on condition continue for 15 min, compressor stop.
 - After 3 min waiting (restart delay), if thermostat is on, compressor restart.

9.4. Heating Mode Operation

9.4.1. Heating indoor fan control

Fan speed manual

- Fan speed [Hi] [Me] [Lo] set by remote controller.
- However, when operation start, or during operation, fan speed control is limited to due to prevent a cold draft, for example, when heating operation start.
- (K10 = Indoor heat exchanger temperature, depend on indoor type)

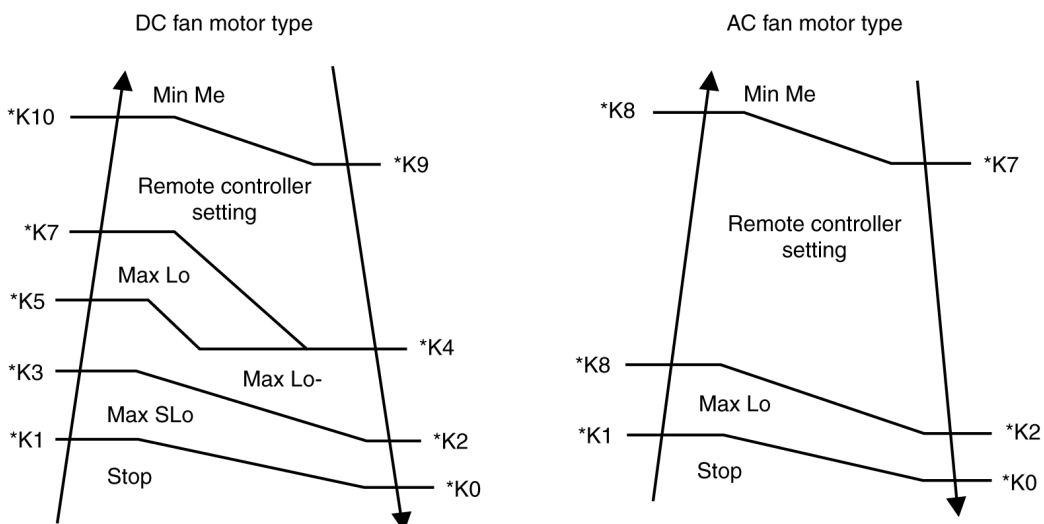

Fan speed auto

- When operation start, or during operation, fan speed control by detecting indoor heat exchanger as follows:
- (K10 = Indoor heat exchanger temperature, depend on indoor type)

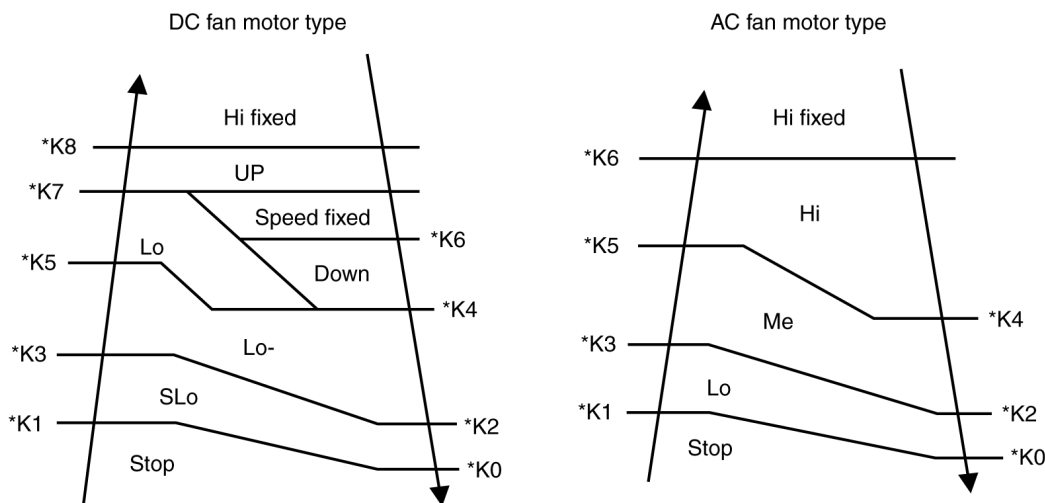

9.4.2. Hot start control

- When heating operation start, hot start control carry out.
- During hot start operation, [PREHEAT] displayed at the wired remote controller.
- For wireless remote controller, [POWER LED] is blinking at the receiver of indoor unit. Indoor fan stop and louver angle fixed to upper side in spite of any setting of remote controller. When indoor heat exchanger temperature increase, or 4 minute past after operation start, hot start control finish and shift to normal fan control.

9.4.3. Heating indoor fan control at thermostat off heating mode operation

- During heating operation, if thermostat is off, indoor fan fixed low speed, Louver angle fixed upper side, even if remote control display shows any angle.
(cassette and ceiling model only)

9.4.4. Heating powerful operation

- When heating mode operation start, temperature differences between setting temperature and room temperature is more than 5 K, setting temperature increase 2 K and operation start.
(however, setting temperature after shifting is more than 31°C, setting temperature fixed 31°C.)
- Due to this control, micro computer judge indoor heat loss is big and increase compressor frequency compare to normal condition, then heat up indoor room quickly.
- This control will be finished after 60 min or thermostat is off.

9.4.5. Defrost control

- During heating operation at outdoor low temperature condition, defrost operation start timely to melt the ice formed on outdoor heat exchanger.
- When heating operation accumulated time is time up, and both outdoor temperature and outdoor unit heat exchanger temperature is less than setting temperature for 5 minute. When defrost temperature is more than setting temperature, defrost operation finish.
- During defrost operation, in spite of any change of remote controller, indoor fan stop and louver angle fixed at upper side.
(for louver control : cassette and ceiling model only)
- During defrost operation, [DEFROST] is displayed at wired remote controller (when using wireless controller, POWER LED is blinking in receiver of indoor unit), hot start operate after defrost operation finish.

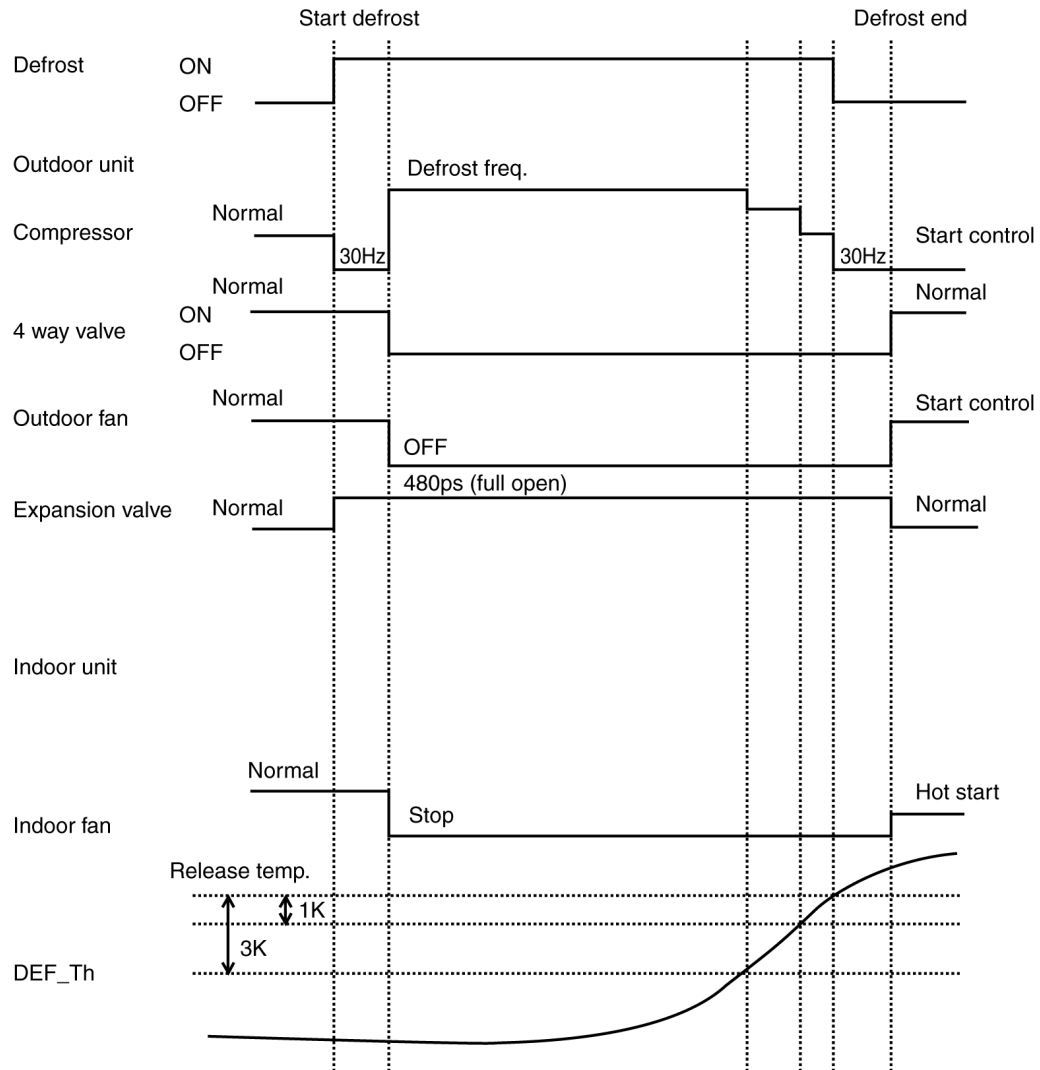

9.4.6. Heating high temperature protection

- During heating operation, when outdoor temperature is more than 35°C for 15 minute, compressor stop to protect compressor.
- After 3 minute (re-start delat control) waiting, if thermostat on condition, outdoor unit re-start.

9.5. Louver Control

9.5.1. Louver control for cassette type

- When power is on, at the same time, louver start initializing toward to close Direction.
- During operation, stopping, thermostat off condition, louver angle set manual or auto depend on remote controller setting.

– Louver manual setting

Operation mode	Display manual	AIR SWING			
		Set 1	Set 2	Set 3	Set 4
Heating	Normal	20°	35°	50°	70°
	Defrost	10°			
	Hot start	10°			
	Thermostat off	20°			
Cooling (fan)	Fan	20°	35°	50°	70°
	Normal	20°	35°	50°	70°
	Dew control	50°			
	Thermostat off	20°	35°	50°	70°
Dry	Normal	30°			
	Dew control	50°			
	Thermostat off	20°	35°	50°	70°
Operation mode judge		20°	35°	50°	70°
Stop mode		0°			

– Louver auto setting

Operation	Display auto set			AIR SWING		
				AUTO 1	AUTO 2	AUTO 3
Heating	Normal	Sensor	A	70°	70°	70°
			B	20° - 70°	20° - 50°	40° - 70°
			C	20°	20°	20°
	Defrost	10°				
	Hot start	10°				
Thermostat off	20°					
Cooling (Fan)	Fan			20° - 70°	20° - 50°	40° - 70°
	Normal			20° - 70°	20° - 50°	40° - 70°
	Dew control			50°		
	Thermostat off			20° - 70°	20° - 50°	40° - 70°
Dry	Normal			30°		
	Dew control			50°		
	Thermostat off			20° - 70°	20° - 50°	40° - 70°
Operation mode judge				20°	20°	20°
Stop mode				0°		

- Temperature range for louver control during heating operation is as follows; decide by indoor heat exchanger temperature.

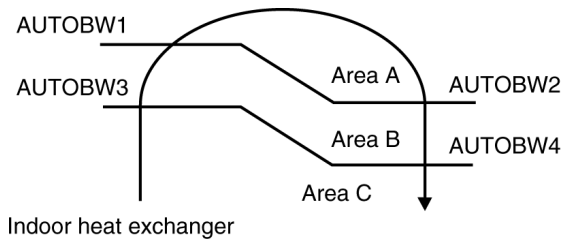

AUTOBW1	AUTOBW2	AUTOBW3	AUTOBW4
60°C	57°C	30°C	25°C

9.5.2. Ceiling type louver control

- When power is on, at the same time, louver initialize 2 times.
- During operation, stopping, thermostat is off condition, louver angle change as below table by manual setting or auto setting of remote controller.

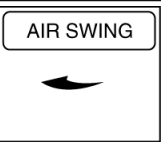
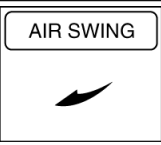
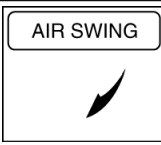
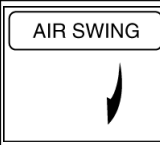
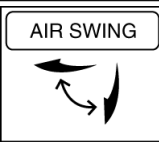
Remote controller setting		Manual				Auto		
Operation mode	Display							
		Set 1	Set 2	Set 3	Set 4	Piping temp (heating)		
						A	B	C
Heating	Normal	20°	35°	50°	70°	70°	20° - 70°	Set 1
	Defrost	20°						
	Hot start	20°						
	Thermostat off	20°						
Cooling (fan)	Fan	20°	35°	50°	70°	20° - 70°		
	Normal	20°	35°	50°	70°	20° - 70°		
	Dew control	35°						
	Thermostat off	20°	35°	50°	70°	20° - 70°		
Dry	Normal	35°						
	Dew control	35°						
	Thermostat off	20°	35°	50°	70°	20° - 70°		
Operation mode judge		20°	35°	50°	70°	20°		
Stop mode		70°						

9.6. Odour Removing Operation

- During stop condition, or cooling operation, when pushing the [ODOUR] button for 5 second, operation change to the odour removing operation.
- Operation detail is as follows;
 - Fan mode operation for 180 second, then refrigerant cycle change to heating mode for 720 second, to heat up (dry) the indoor unit. Compressor frequency and indoor fan controlled to maintain the indoor heat exchanger temperature 41°C.
- Indoor fan revolution is fixed (for DC motor type, fan speed is Slo, for AC motor type, fan speed is Lo), and indoor louver angle is fixed manual set no.1.
- After that, fan mode operation continue for 360 second, then odour removing operation finish.
- During odour removing operation, [ODOUR] sign is blinking at LCD display panel of wired remote controller ([ODOUR WASH] sign is not displayed for wireless remote controller), when pushing the operation button, or [ODOUR] button, odour removing operation finish and set the odour cut operation.

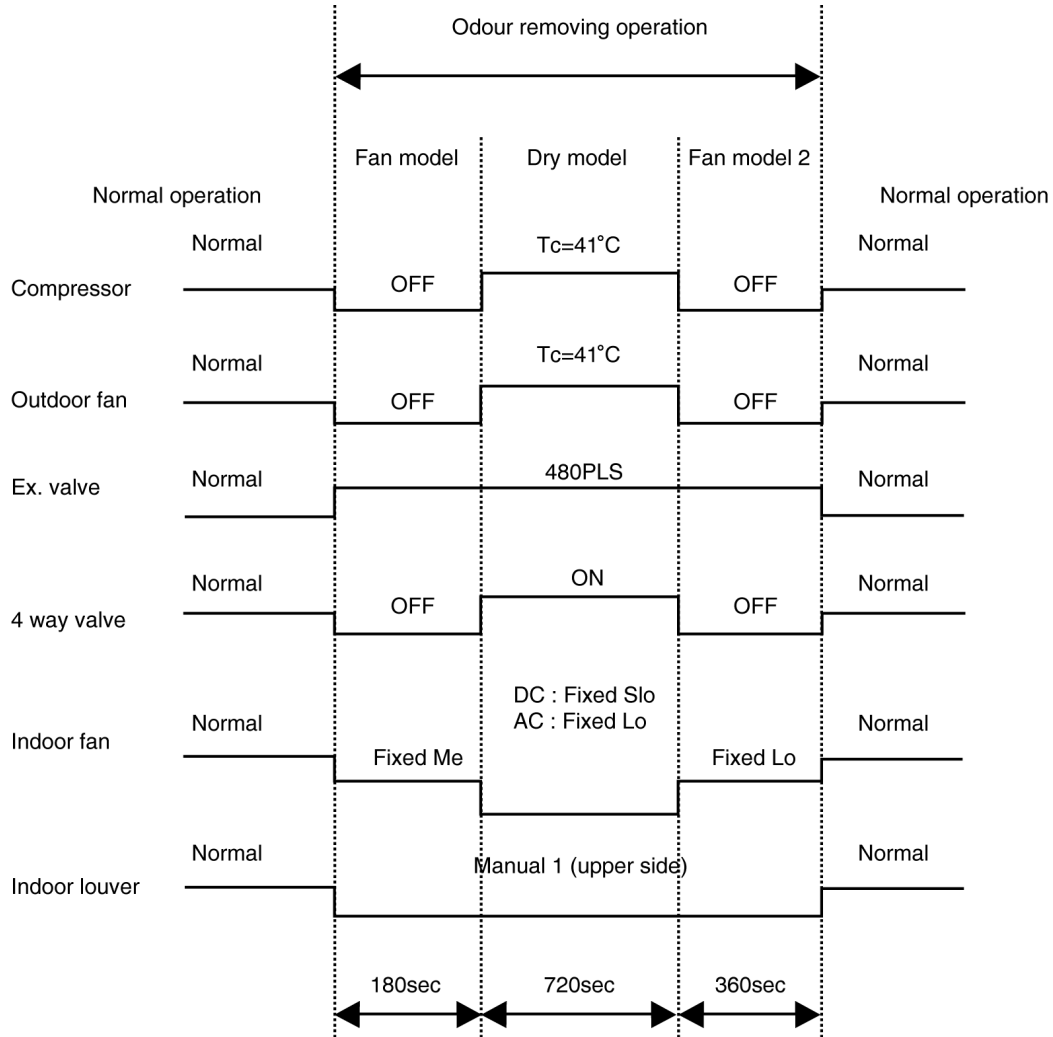

9.7. Energy Save Operation

- During cooling operation, or heating operation, when pushing the [ECONOMY] button in the wired remote controller, energy save operation start and [ECO] sign is displayed at LCD display panel of wired remote controller ([ECONOMY] sign is displayed at LCD display panel of wireless remote controller).
- When energy save operation start and temperature differences is +1K (=indoor suction temperature - setting temperature) for cooling operation, or -1K for heating operation for 30 minute, thermostat OFF point shift to 0.5K.
(This means thermostat OFF point shift up +0.5K for cooling, thermostat OFF point shift down -0.5K for heating)
From this control, it is judged that indoor side heat loss is small, then reduce compressor frequency. This means energy save operation.
- Those kind of operation continue maximum 4 times. If temperature is out of range (thermostat off +1K for cooling, thermostat off -1K for heating), operation release from energy save control. But energy save control cannot be released by pushing ON/OFF button of remote controller, but still effective. When pushing [ECONOMY] button once again, energy save control released.

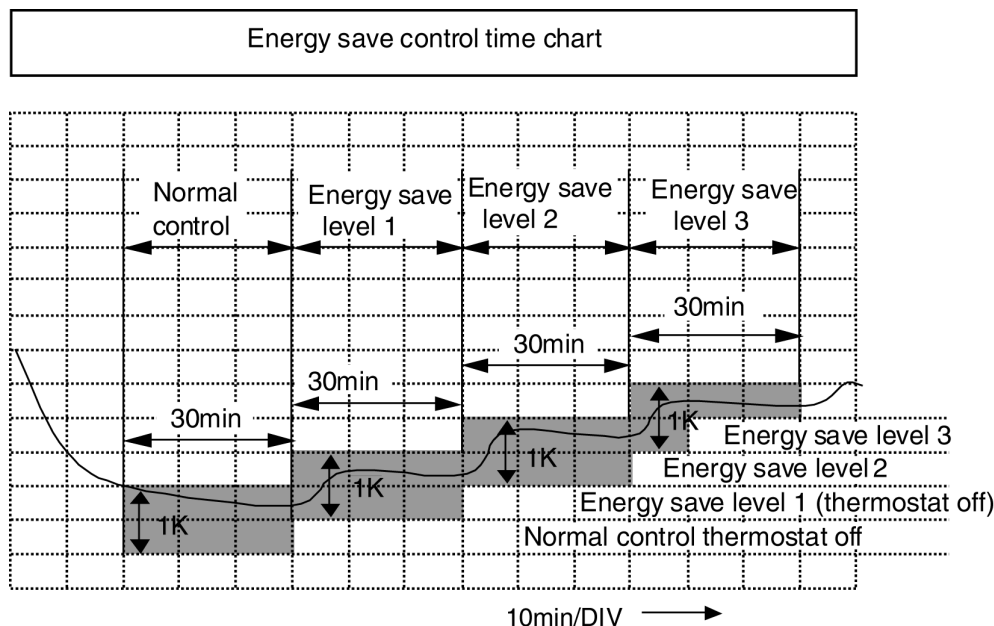

9.8. Outdoor Fan Remaining Heat Removal Control

- When compressor stop, outdoor fan operate for 1 minute to remove the remaining heat.

9.9. Crank Case Heater Control

- Crank case heater power is on to prevent the refrigerant solving into compressor oil inside of the compressor shell at cold condition.
- When below conditions are satisfied, crank case heater power on.
 - Compressor stop
 - Outdoor temperature $\leq 15^{\circ}\text{C}$
 - Compressor discharge temperature $\leq 15^{\circ}\text{C}$

9.10. Valve Error

- When install the air conditioner unit and try to start forced operation (cooling mode) after completion the installation, in case of 3 way valve close, valve error displayed at the wired remote controller to protect the compressor.
- This error can be detected to satisfy below condition, when power is on at first time and within 7 minute from compressor start.
(However, it is judged that power on is the first time until compressor start operating continuously for 7 minute)
 - Indoor heat exchanger temperature when compressor start - 3K < current indoor heat exchanger temperature for 5 minute
 - Indoor suction temperature - 3K < current heat exchanger temperature for 5 minute.

9.11. Pump Down Operation

- When pushing the [PUMP DOWN] button on the outdoor PCB for 1 second, pump down operation start. Detail of pump down operation is shown at below table.
- During pump down operation, push the [PUMP DOWN] button once again for 1 second, pump down operation stop.
- After 600[Sec] past, pump down operation stop.

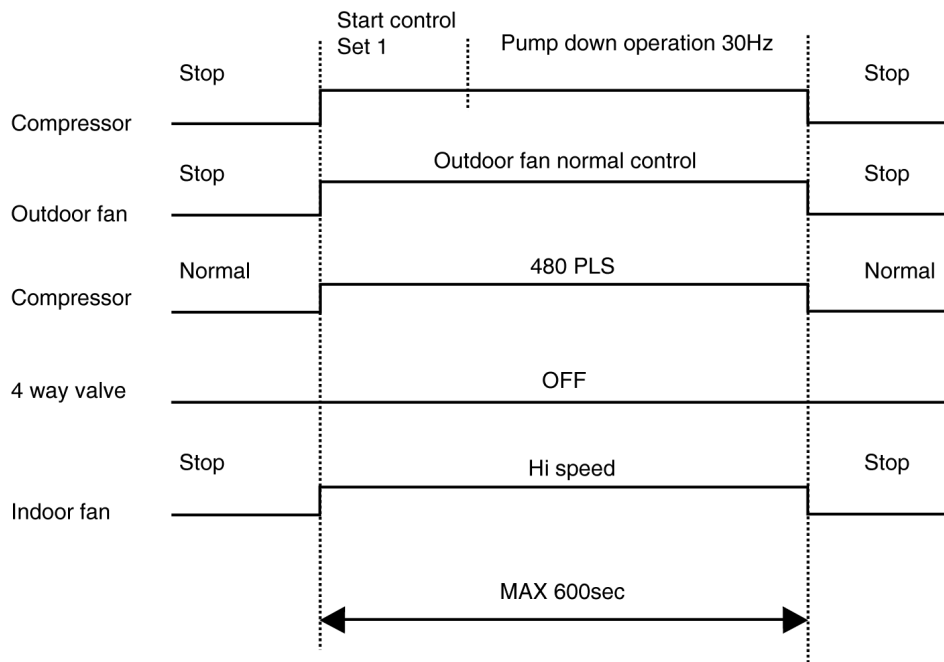
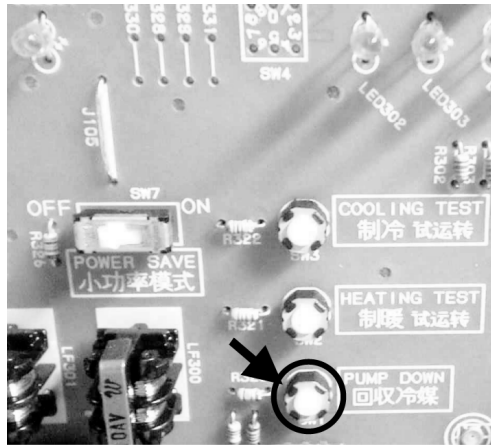

9.12. Indoor Air Volume Up Control (DC Fan Motor Type Only)

- Indoor air volume up control set by local setting mode of wired or wireless remote controller.
(item 01, 00: standard / 01: Air volume up mode)
(only for DC motor type)
- Due to air volume up control, indoor fan revolution increase in case of Hi speed setting only.
- This control is memorized in the micro computer, it cannot be reset by power off.

10 INSTALLATION INSTRUCTION

10.1. Pipe Length

10.1.1. Correction of cooling and heating capacities

Correction of cooling and heating capacities according to the connecting pipe length.

The data of cooling capacities (marked on the name plate) are based on 7.5 metres connecting pipe and horizontal installation.

(Cooling)

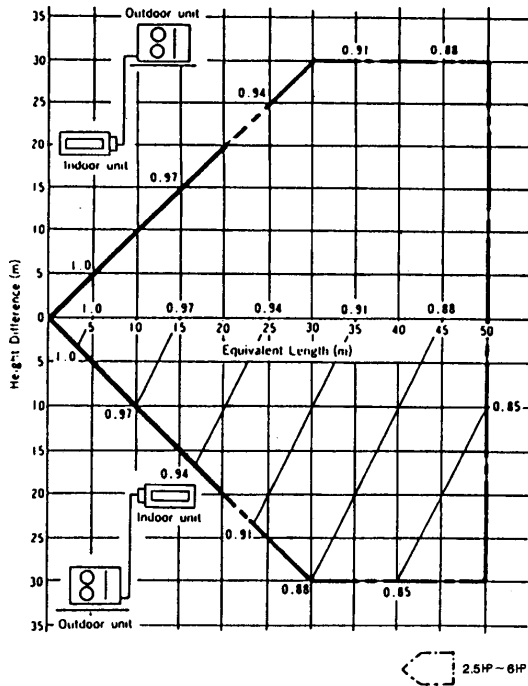

Equivalent Length = actual pipe length + number of elbow x ELE + number of oil trap x ELO

ELE : equivalent length of elbow.

ELO : equivalent length of oil trap.

10.1.2. Refrigerant additional charge

- The piping length exceeds 30 metres.
APPLICABLE FOR ALL MODELS

Before shipment, this air conditioner is filled with the rated amount of refrigerant subject to 30m piping length. (The rated amount of refrigerant is indicated on the name plate.) But when the piping length exceeds 30m, additional charge is required according to the following table.

For other pipe length of other installation multiply by the following correction factor to determine the revised cooling capacity.

(Heating)

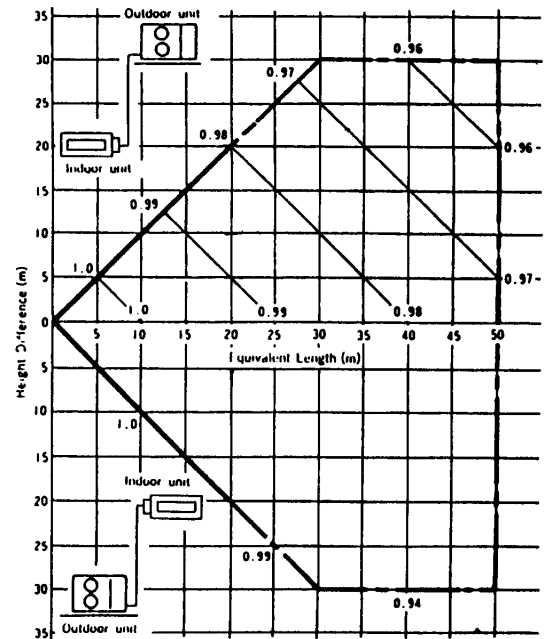

Outer diameter of gas side pipe mm (inch)	ELE 
9.52	0.18
12.7 (1/2)	0.20
15.88 (5/8)	0.25
19.05 (3/4)	0.35

Model	Ref. Charge
2.5-6HP	50g per 1m

Example :

CS-F50DD2E5

In case of 31m long pipe (one-way), the amount of refrigerant to be replenished is:
(31 - 30) x 50 = 50g

10.2. Indoor unit installation



DUCT TYPE AIR CONDITIONERS INSTALLATION INSTRUCTIONS

**REFRIGERANT
R410A**

HP	Model name
2.5 HP	CS-F24DD2E5
3 HP	CS-F28DD2E5
4 HP	CS-F34DD2E5
5 HP	CS-F43DD2E5
6 HP	CS-F50DD2E5

Precautions in terms of safety

Carry out installation work with reliability after thorough reading of this "Precautions in terms of safety".

- Precautions shown here are differentiated between  Warnings and  Cautions. Those that have much chances for leading to significant result such as fatality or serious injury if wrong installation would have been carried out are listed compiling them especially into the column of .

However, even in the case of items which are listed in the column of , such items also have a chance for leading to significant result depending on the situations.

In either case, important descriptions regarding the safety are listed, then observe them without fail.

- As to indications with illustration



This mark means "Caution" or "Warning".















This mark means "Earth".

- After installation work has been completed, do not only make sure that the unit is free from any abnormal condition through the execution of trial run but also explain how to use and how to perform maintenance of this unit to the customer according to the instruction manual.

In addition, request the customer to keep this manual for installation work together with the instruction manual.

Warnings

<p> The appliance must be installed by technician, who takes into account the requirements given by ISO5149 or eventual equivalent requirements.</p>	<p> If installing inside a small room, measures should be taken to prevent refrigerant levels from building up to critical concentrations in the event of a refrigerant leak occurring. Please discuss with the place of purchase for advice on what measures may be necessary to prevent critical concentrations being exceeded. If the refrigerant leaks and reaches critical concentration levels, there is the danger that death from suffocation may result.</p>
<p> As to installation, request the distributor or vendor to perform it. Imperfection in installation caused by that having been carried out by the customer himself may lead to water leakage, electric shock, fire, etc.</p>	<p> Securely attach the protective covers for the outdoor unit connection cables and power cord so that they do not lift up after installation. If the covers are not properly attached and installed, the terminal connections may overheat, and fire or electric shock may result.</p>
<p> Carry out the installation work with reliability according to this manual for installation work. Imperfection in installation leads to water leakage, electric shock, fire, etc.</p>	<p> Switch off all supplies before accessing any electrical part.</p>
<p> Carry out the installation work with reliability on the place that can bear the weight of this unit sufficiently. Insufficient strength leads to injury due to falling of the unit.</p>	<p> If refrigerant gas escapes during installation, ventilate the affected area. If the refrigerant gas comes into contact with sparks or naked flames, it will cause toxic gases to be generated.</p>
<p> Carry out predetermined installation work in preparation for strong wind such as typhoon, earthquake. Imperfection in installation work may lead to accidents arisen from overturn, etc.</p>	<p> Once installation work is completed, check that there are no refrigerant gas in the room that can come into contact with sparks or flames from a fan heater, stove or kitchen range, which will cause toxic gases to be generated.</p>
<p> The unit must be installed in accordance with applicable national and local regulations. Any electrical work should only be carried out by qualified technician and use exclusive circuits without fail. Presence of insufficient capacity in power circuit or imperfection in execution leads to electric shock, fire, etc.</p>	<p> When performing piping work do not mix air except for specified refrigerant (R410A) in refrigeration cycle. It causes capacity down, and risk of explosion and injury due to high tension inside the refrigerant cycle.</p>

⚠ Warnings

- ▲ Wiring shall be connected securely using specified cables and fix them securely so that external force of the cables may not transfer to the terminal connection section. Imperfect connection and fixing leads to fire, etc.

⚠ Cautions

- ▲ Carry out Earthing work. Do not connect the Earth return to the gas pipe, water line pipe, lightning rod and telephone lines. Imperfection in Earth return may lead to electric shock. 
- ▲ Do not install the unit at the place where the possibility of inflammable gas leakage exists. If such gas leakage should arise and the gas builds up around the unit, such situation may lead to ignition.
- ▲ Mounting of the earth leakage circuit breaker is required. Omission in mounting of the earth leakage circuit breaker may lead to electric shock.
- ▲ Drain piping should be made to ensure secure drainage according to the manual for installation work and carry out the thermal insulation to prevent the occurrence of condensation. Imperfection in piping work leads to water leakage and may cause the house and property, etc. to become wet
- ▲ Position the indoor unit, outdoor unit, power cords and indoor/outdoor unit connection cables in a way so that they are at least 1 meter away from televisions and radios. This is to avoid problem such as interference with picture and/or sound. (However, note that depending on the electromagnetic wave conditions, interference may still occur even if the separation distance is more than 1 meter.)

10.2.1. Accessories packed in the indoor unit container

NO.	Parts name	Q'ty
1	Thermal insulator for refrigerant pipe	2
2	Hose clip for thermal insulator	5
3	M10 Flange washer	4
4	M10 Flat washer	4
5	Thermal insulator for drainage hole	1
6	Flexible hose	1

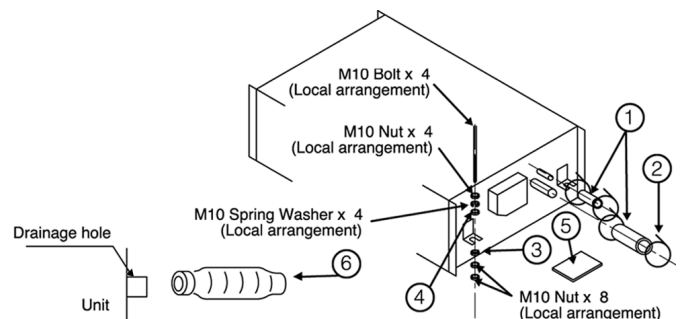

10.2.2. Selecting the location for the indoor unit

Provide a check port on the piping side ceiling for repair and maintenance.

- Install the indoor unit once the following conditions are satisfied and after receiving the customer approval.
 1. The indoor unit must be within a maintenance space.
 2. The indoor unit must be free from any obstacles in path of the air inlet and outlet, and must allow spreading of air throughout the room.

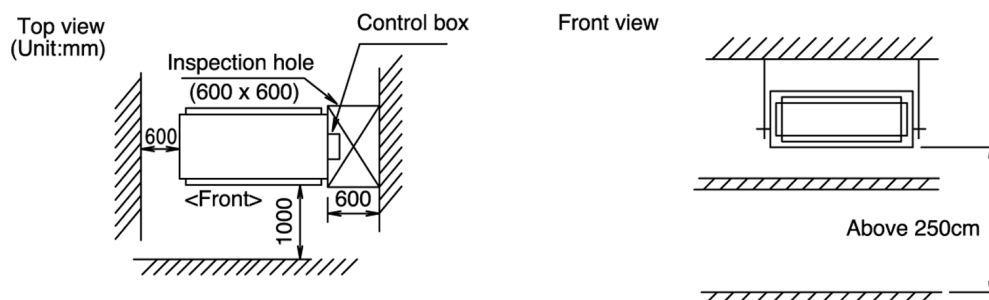

*If the height from the floor to ceiling exceeds three meters, air flow distribution deteriorates and the effect is decreased.

3. The installation position must be able to support a load four times the indoor unit weight. ⚠ Warnings
4. The indoor unit must be away from heat and steam sources, but avoid installing it near an entrance.
5. The indoor unit must allow easy draining.
6. The indoor unit must allow easy connection to the outdoor unit.
7. Place the indoor unit easy water drainage. (Suitable dimension "H" is necessary to get slop to drain as figure.)
8. The indoor unit must be from at least 3m away from any noise-generating equipment. The electrical wiring must be shielded with a steel conduit.

9. If the power supply is subject to noise generation, add a suppressor.
10. Do not install the indoor unit in a laundry. Electric shocks may result.

Note

- Thoroughly study the following installation locations.
 1. In such places as restaurants and kitchens, considerable amount of oil steam and flour adhere to the turbo fan, the fin of the heat exchanger and the drain pump, resulting in heat exchange reduction, spraying, dispersing of water drops, drain pump malfunction, etc.

In these cases, take the following actions:

- Make sure that the ventilation fan for smoke-collecting hood on a cooking table has sufficient capacity so that it draws oily steam which should not flow into the suction of the air conditioner.
- Make enough distance from the cooking room to install the air conditioner in such place where it may not suck in oily steam.

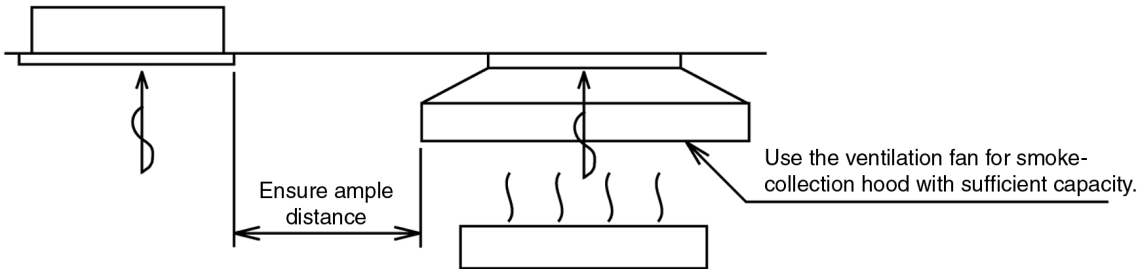

2. Avoid installing the air conditioner in such circumstances where cutting oil mist or iron powder exist especially in factories, etc.
3. Avoid places where inflammable gas is generated, flows-in, contaminated, or leaked.
4. Avoid places where sulphurous acid gas or corrosive gas can be generated.
5. Avoid places near high frequency generators.

Front view

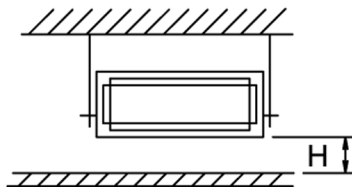

10.2.3. Installation of indoor unit

POSITION OF SUSPENSION BOLT

- Apply a joint-canvas between the unit and duct to absorb unnecessary vibration.
- Install the unit leaning to a drainage hole side as a figure for easy water drainage.

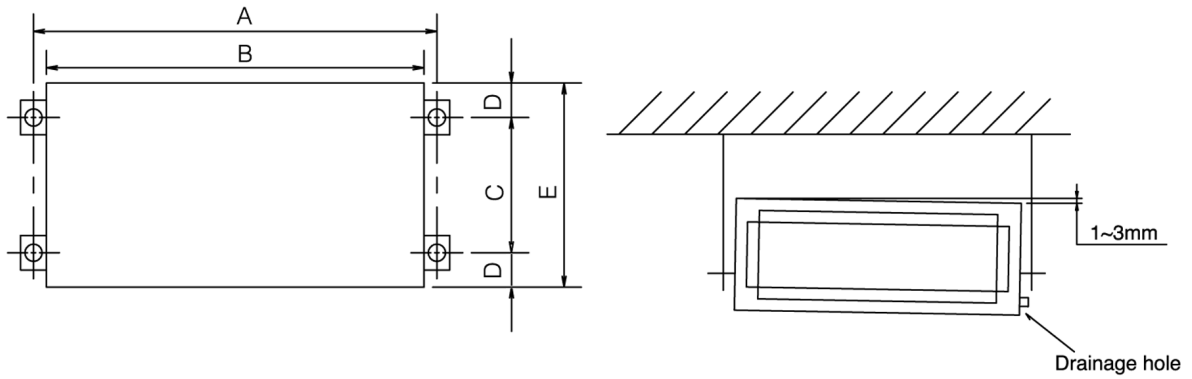

(unit: mm)

	A	B	C	D	E
CS-F24DD2E5	1060	1000	430	35	500
CS-F28DD2E5					
CS-F34DD2E5	1060	1000	540	55	650
CS-F43DD2E5					
CS-F50DD2E5					

10.2.4. Refrigerant piping

- Refrigerant is charged to the outdoor unit. For details, see the manual for installation work of outdoor unit. (Additional charging, etc.)

1. Brazing for piping.

- Execute brazing before tightening the flare nut.
- Brazing must be executed while blowing nitrogen gas. (This prevents generation of oxidized scale in copper pipe.)

2. When there is a lot of brazings for long piping, install a strainer midway of the piping. (The strainer is locally supplied.)

3. Use clean copper pipe with inner wall surface free from mist and dust. Blow nitrogen gas or air to blow off dust in the pipe before connection.

4. Form the piping according to its routing. Avoid bending and bending back the same piping point more than three times. (This will result in hardening of the pipe).

5. After deforming the pipe, align centers of the union fitting of the indoor unit and the piping, and tighten them firmly with wrenches.

6. Connect pipe to the service valve or ball valve which is located below the outdoor unit.

7. After completed the piping connection, be sure to check if there is gas leakage in indoor and outdoor connection.

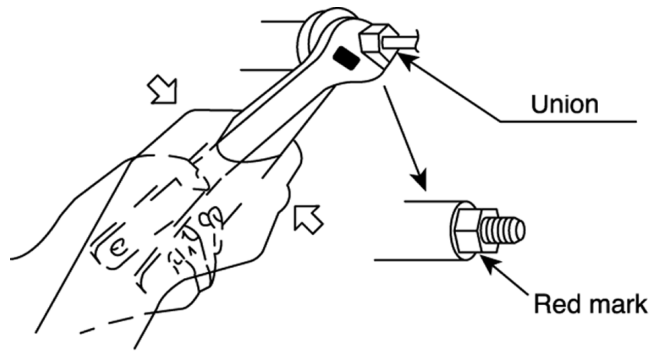

- Confirm the red mark of the union (thin side) is always at lower direction after connecting piping.

Vacuum drying

After completing the piping connection, execute vacuum drying for the connecting piping and the indoor unit.

The vacuum drying must be carried out by using the service ports of both the liquid and gas side valves.

CAUTION Use two wrenches and tighten with regular torque.

Flare nut fastening torque N.m (kgf.cm)					
ø6.35 mm	18 (180)	ø12.7 mm	55 (560)	ø19.05 mm	100 (1020)
ø9.52 mm	42 (430)	ø15.88 mm	65 (660)		

Liquid side piping	Gas side piping
ø9.52 mm	ø15.88 mm

10.2.5. Indoor unit drain piping

- The unit has two drainage holes at both side.
The drainage hole without connection needs seal and thermal insulation with accessories.



- Always lay the drain with downward inclination (1/50 to 1/100). Prevent any upward flow or reverse flow in any part.
- 5mm or thicker formed thermal insulator shall always be provided for the drain pipe.

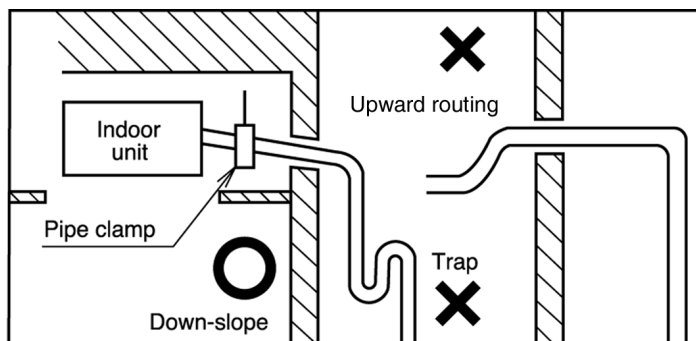
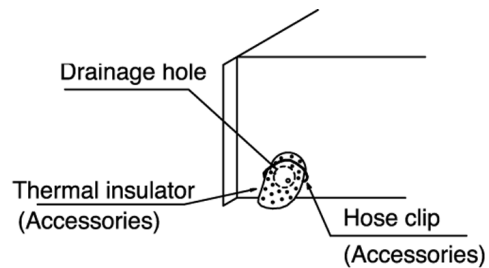

10.2.6. Heat Insulation

⚠ Caution Be sure to perform heat insulation on the drain, liquid and gas piping. Imperfection in heat insulation work leads to water leakage.

1. Use the heat insulation material for the refrigerant piping which has an excellent heat-resistance (over 120°C).

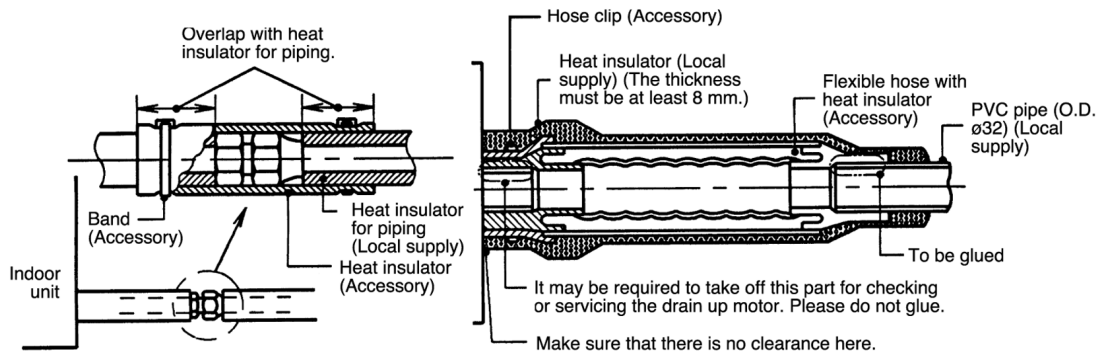

2. Precautions in high humidity circumstance.

This air conditioner has been tested according to the "JIS Standard Conditions with Mist" and have been confirmed that there are no faults. However, if it is operated for a long time in high humid atmosphere (dew point temperature: more than 23°C), water drops are liable to fall. In this case, add heat insulation material according to the following procedure:

- Heat insulation material to be prepared... Adiabatic glass wool with thickness 10 to 20mm.
- Stick glass wool on all air conditioners that are located in ceiling atmosphere.
- In addition to the normal heat insulation (thickness: more than 8mm) for refrigerant piping (gas piping: thick piping) and drain piping, add a further of 10mm to 30mm thickness material.

Wall seal

- When the outdoor unit is installed on a higher position than the indoor unit, install the trap so as not to instill rain water into the wall by transmitting in piping.
- Stuff the space among piping, the electric wire, and the drain hose with "Putty" and seal the penetration wall hole.
Make sure that rain water do not instill into the wall.

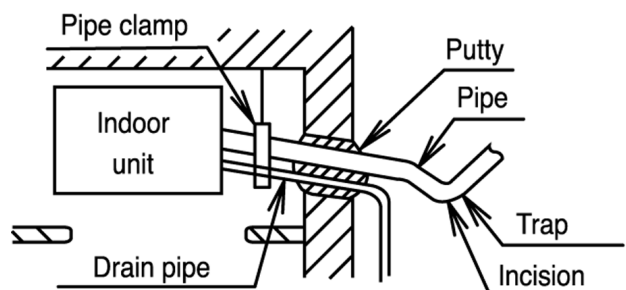

*Put the incision at the trap part of the heat insulator (for water drain)

10.2.7. Electrical wiring

As to main power source and cable size of outdoor unit, read the installation manual attached to the outdoor unit.

⚠ Warning	The units must be installed in accordance with applicable national and local regulations. The units installed by a professional installer must be supplied from a dedicated electrical circuit. All electrical work must be carried out by a qualified technician according to proper technical standards for electrical work and according to installation manual for installation work. If circuit with insufficient capacity are used, or if electrical work is not carried out properly, electric shocks or fire may result.
⚠ Caution	Be sure to install a current leakage breaker or circuit breaker to the main power supply, otherwise electric shocks may result.
⚠ Caution	Be sure to connect the unit to secure earth connection. (with an earth resistance of 100 Ω or less) If the earthing work is not carried out properly, electric shocks may result.
⚠ Warning	Wiring shall be connected securely using specified cables and fix them securely so that external force of the cables may not transfer to the terminal connection section. Imperfect connection and fixing leads to fire, etc.



1. Select a power source that is capable of supplying the current required by the air conditioner.
2. Feed the power source to the unit via a distribution switch board designed for this purpose, the switch should disconnected all poles with a contact separation of at least 3 mm.

3. Always ground the air conditioner with a grounding wire and screw to meet the LOCAL REGULATIONS.
4. Be sure to connect the wires correctly to terminal board with connecting the crimp type ring terminal to the wires.
5. Be sure to turn off the main power before installing and connecting the remote controller.

Note If momentarily turning on the power supply for both the indoor and outdoor units, do not turn the power off after at least 1 minute has passed. (For the system's automatic setting.)
Turning off the power supply on the way may cause an abnormal operation.

- Use the standard power cord for Europe (such as H05RN-F or H07RN-F which conforms to CENELEC (HAR) rating specifications) or use the cables based on IEC standard. (245IEC57, 245IEC66)

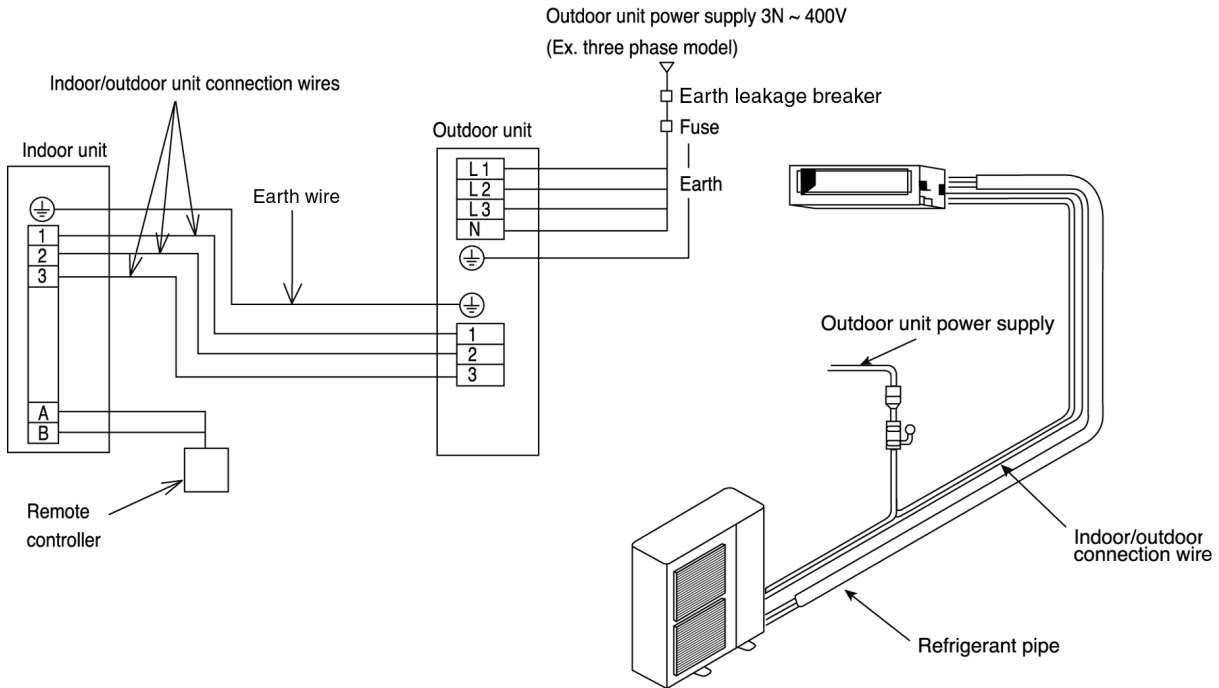

CONNECTING THE WIRES TO THE CONTROL BOX

- Remove two screws ①, remove the control box cover, and then connect the wires by following the procedure given in the illustration.

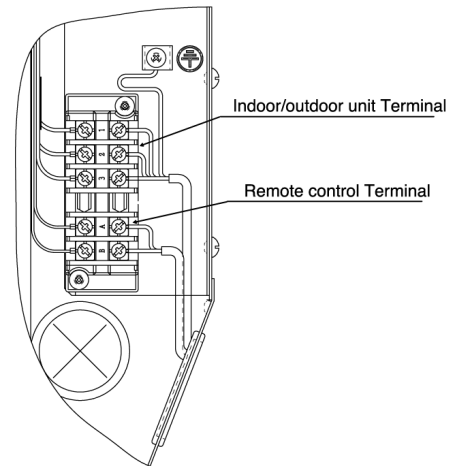
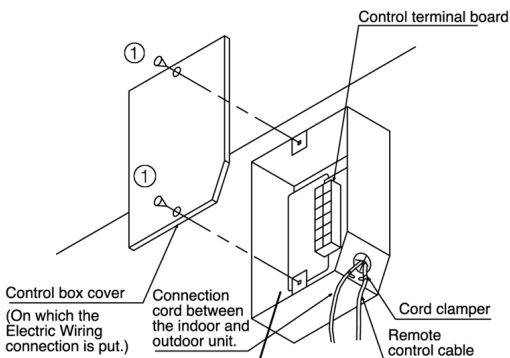

Earth lead wire shall be longer than other lead wires as shown in the figure for the electrical safety in case of the slipping out of the cord from anchorage.

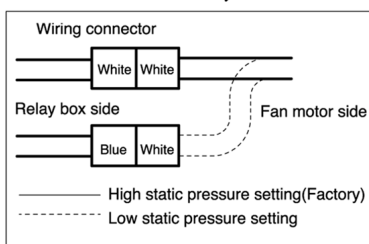

<INDOOR UNIT>

- Remove the control box for electrical connection between the indoor and outdoor unit. (Remove two screws ①).
- Use the cord clammer to fix the cord.

Caution
Make sure that screws of the terminal are free from Looseness.
Fastening torque
M4... 118N.cm (12kgf.cm)
M5... 196N.cm (20kgf.cm)

10.2.8. Settings

*Do not operate the remote controller within 1 minute after turning on the power of the indoor unit.

*When using group control with the standard type, at least 1 unit must be set at No.1 at the indoor unit.

*Check the settings of the indoor unit in a case where there are no display at remote controller. If there is no problem to the settings, either group control or standard type should be set at No.16 at the indoor unit before turning the power on again.

- All sets in the group which uses the same remote controller thermistor settings can be controlled by the same remote controller thermistor.
- Up to a maximum of 16 indoor units can be connected at the time of group control. (Do not connect heat pump unit with cooling only unit.)
- Indoor unit No. will be set automatically at the time of group control. However, which indoor unit uses which number is unknown. Indoor unit No. is also possible to be set manually with DIP switches. Since manual address setting has priority to automatic address setting. To perform automatic address setting after doing manual setting, turn off all DIP switches from No.1 to No.4, and then stop the operation. Then press three switches such as [AIR SWING AUTO]• [MODE]• [A/C No.] at the same time. (Do not use manual address setting and automatic address setting together.)
- Centralized control is possible for master unit and slave unit at the time of group control.

Indoor unit No.		1	2	3	4	5	6	7	8
Manual Setting	DIP switch (SW2) address setting on indoor unit printed circuit board.								
	A/C No. setting	Unnecessary operation	1-ON	2-ON	1,2-ON	3-ON	1,3-ON	2,3-ON	1,2,3-ON
	Indoor unit No.	9	10	11	12	13	14	15	16
	DIP switch (SW2) address setting on indoor unit printed circuit board.								
A/C No. setting	4-ON	1,4-ON	2,4-ON	1,2,4-ON	3,4-ON	1,3,4-ON	2,3,4-ON	1,2,3,4-ON	

(Remote Controller address setting)

(Refer to the Installation Manual which is provided with the remote controller for details.)

- Two remote controllers (including the wireless remote controller) can be connected. However, remote control thermistor setting is not possible.
- As for [master/slave] setting of remote controller, the automatic setting and manual setting are possible. Since manual setting is priority.
- Two remote controllers, which both are wireless, cannot be connected.

10.2.9. As for timer output

- Connect the timer cord to connector (CN-TIMER) on print circuit board.

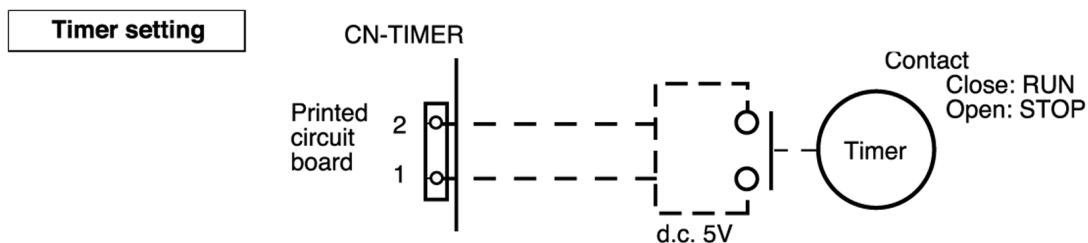

10.2.10. Precautions in test run

- The initial power supply must provide at least 90% of the rated voltage. Otherwise, the air conditioner may not operate.
- Test operation can be carried out using the remote control unit or at the outdoor unit. (If carrying out test operation at the outdoor unit, refer to "TEST OPERATION" in the outdoor unit installation manual.)
- If using the remote control unit to carry out test operation, follow the procedure given below.



- First, press the OFF/ON (①) button.
- Then press the TEST RUN button within 1 minute of pressing the OFF/ON (①) button.
- Next, select the operation modes.
- The temperature of the indoor unit pipes will be shown on the temperature setting display. (At the start of the test operation, it may take up to 1 minute for air conditioner number, switching time and other displays to appear.)
- After operation modes have been selected, stop the compressor for a moment.
- Press the OFF/ON (①) button of the TEST RUN button once more to cancel test operation mode.

NOTE 1 These units are equipped with connection error prevention circuits. If the units do not operate, it is possible that the connection error prevention circuits have been operated. In such cases, check that the Indoor/outdoor unit connection wire (connected to terminals ①, ② and ③) is connected correctly. If they are connected incorrectly, connect them correctly. Normal operation should then commence.

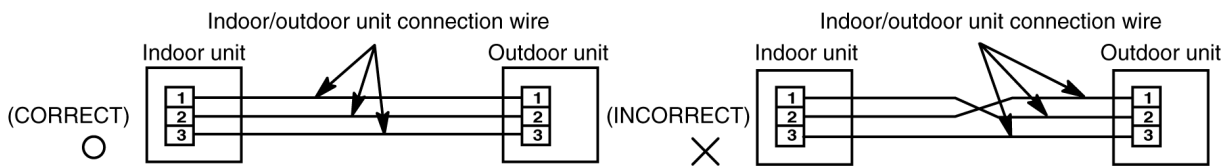

NOTE 2 Do not short the remote control unit wires to each other. (The protection circuit will be activated and the units will not operate.) Once the cause of the short is eliminated, normal operation will then be possible.

NOTE 3 When running the units in heating mode during test operation, be sure to run the units in cooling mode first before selecting this mode. If heating mode is selected first, it may cause problems with operation of the compressor. (Heat pump model only.)

NOTE 4 Test operation should be carried out for a minimum of 5 minutes. (Test operation will be cancelled automatically after 30 minutes.)

NOTE 5 Test operation mode should always be cancelled once test operation itself has been completed.

10.2.11. Check the following items when installation is complete

- After completing work, be sure to measure and record trial run properties, and store measuring data, etc.
- Measuring items are room temperature, outside temperature, suction temperature, blow out temperature, wind velocity, wind volume, voltage, current, presence of abnormal vibration and noise, operating pressure, piping temperature, compressive pressure, airtight pressure.
- As to the structure and appearance, check the following items.

- | | |
|--|--|
| <input type="checkbox"/> Is circulation of air adequate? | <input type="checkbox"/> Is remote controller switch operated? |
| <input type="checkbox"/> Is draining smooth? | <input type="checkbox"/> Is there any faulty wiring? |
| <input type="checkbox"/> Is heat insulation complete (refrigerant and drain piping)? | <input type="checkbox"/> Are the terminal screws loosened? |
| <input type="checkbox"/> Is there any leakage of refrigerant? | |
- M3... 69-98N.cm {7-10kgf.cm}
M4... 157-196N.cm {16-20kgf.cm}
M5... 196-245N.cm {20-25kgf.cm}

10.2.12. Hand over

- Teach the customer the operation and maintenance procedures, using the operation manual (air filter cleaning, temperature control, etc.)

As to parts to be sold separately

- With regards to installation of the parts sold separately, follow the installation manual which is provided with the parts sold separately.

As for work specifications of the outdoor unit, read the **OUTDOOR UNIT INSTALLATION MANUAL** attached to the outdoor unit.

10.3. Outdoor unit installation



AIR CONDITIONERS OUTDOOR UNIT INSTALLATION INSTRUCTIONS

**REFRIGERANT
R410A**

HP	Model name
2.5 HP	CU-L24DB**
3 HP	CU-L28DB**
4 HP	CU-L34DB**
5 HP	CU-L43DB**
6 HP	CU-L50DB**

Precautions in terms of safety

Carry out installation work with reliability after thorough reading of this "Precautions in terms of safety".

- Precautions shown here are differentiated between  **Warnings** and  **Cautions**. Those that have much chances for leading to significant result such as fatality or serious injury if wrong installation would have been carried out are listed compiling them especially into the column of .

However, even in the case of items which are listed in the column of , such items also have a chance for leading to significant result depending on the situations.

In either case, important descriptions regarding the safety are listed, then observe them without fail.

- As to indications with illustration



This mark means "Caution" or "Warning".



This mark means "Earth".

- After installation work has been completed, do not only make sure that the unit is free from any abnormal condition through the execution of try run but also explain how to use and how to perform maintenance of this unit to the customer according to the instruction manual.

In addition, request the customer to keep this manual for installation work together with instruction manual.

Warnings

<p>▲ The appliance must be installed by technician, who takes into account the requirements given by ISO5149 or eventual equivalent requirements.</p>	<p>▲ If installing inside a small room, measures should be taken to prevent refrigerant levels from building up to critical concentrations in the event of a refrigerant leak occurring. Please discuss with the place of purchase for advice on what measures may be necessary to prevent critical concentrations being exceeded. If the refrigerant leaks and reaches critical concentration levels, there is the danger that death from suffocation may result.</p>
<p>▲ As to installation, request the distributor or vendor to perform it. Imperfection in installation caused by that having been carried out by the customer himself may lead to water leakage, electric shock, fire, etc.</p>	<p>▲ Securely attach the protective covers for the outdoor unit connection cables and power cord so that they do not lift up after installation. If the covers are not properly attached and installed, the terminal connections may overheat, and fire or electric shock may result.</p>
<p>▲ Carry out the installation work with reliability according to this manual for installation work. Imperfection in installation leads to water leakage, electric shock, fire, etc.</p>	<p>▲ Switch off all supplies before accessing any electrical part.</p>
<p>▲ Carry out the installation work with reliability on the place that can bear the weight of this unit sufficiently. Insufficient strength leads to injury due to falling of the unit.</p>	<p>▲ If refrigerant gas escapes during installation, ventilate the affected area. If the refrigerant gas comes into contact with sparks or naked flames, it will cause toxic gases to be generated.</p>
<p>▲ Carry out predetermined installation work in preparation for strong wind such as typhoon, earthquake. Imperfection in installation work may lead to accidents arisen from overturn, etc.</p>	<p>▲ Once installation work is completed, check that there are no refrigerant gas in the room that can come into contact with sparks or flames from a fan heater, stove or kitchen range, which will cause toxic gases to be generated.</p>
<p>▲ The unit must be installed in accordance with applicable national and local regulations. Any electrical work should only be carried out by qualified technician and use exclusive circuits without fail. Presence of insufficient capacity in power circuit or imperfection in execution leads to electric shock, fire, etc.</p>	<p>▲ When performing piping work do not mix air except for specified refrigerant (R410A) in refrigeration cycle. It causes capacity down, and risk of explosion and injury due to high tension inside the refrigerant cycle.</p>

⚠ Warnings

▲ Wiring shall be connected securely using specified cables and fix them securely so that external force of the cables may not transfer to the terminal connection section.
Imperfect connection and fixing leads to fire, etc.

⚠ Cautions

▲ Carry out Earthing work.
Do not connect the Earth return to the gas pipe, water line pipe, lightning rod and telephone lines. Imperfection in Earth return may lead to electric shock.

▲ Do not install the unit at the place where the possibility of inflammable gas leakage exists. If such gas leakages should arise and the gas builds up around the unit, such situation may lead to ignition.

▲ Mounting of the earth leakage circuit breaker is required. Omission in mounting of the earth leakage circuit breaker may lead to electric shock.



▲ Drain piping should be made to ensure secure drainage according to the manual for installation work and carry out the thermal insulation to prevent the occurrence of condensation. Imperfection in piping work leads to water leakage and may cause the house and property, etc. to become wet

▲ Position the indoor unit and outdoor unit, power cords and indoor/outdoor unit connection cables in a way so that they are at least 1 meter away from televisions and radios. This is to avoid problem such as interference with picture and/or sound. (However, note that depending on the electromagnetic wave conditions, interference may still occur even if the separation distance is more than 1 meter.)

10.3.1. Accessories supplied with outdoor unit

- The following parts are supplied as accessories with each outdoor unit.

Check that all accessory parts are present before installing the outdoor unit.

Part name	Q'ty	Diagram	Application
Protective bushing	2		For protecting electrical wires
Banding strap	3		For tying electrical wires together

Heat pump-types only			
Part name	Q'ty	Diagram	Application
Drain elbow AS	1		For connecting the drain pipe (with ring seat)

10.3.2. Before installation work

- This product is using new refrigeration (R410A). The basic way of installation work is the same as usual, but water and impurities should be controlled more strictly than before due to characteristic of refrigerating machine oil. Therefore, selection of materials to use and processing, storing and brazing need appropriate construction and control.

1. Tools and materials

There are tools and materials for both new refrigeration and usual refrigeration you can use together and for either two of them you can use. Use the below for new refrigeration.

- Vacuum pump (with back flow preventor system)
- Gas leakage detection warning device
- Gauge manifold
- Charge hose

2. Installation work

a. Brazing work

Brazing work needs replacing air inside pipe with nitrogen gas in order to prevent oxidization scale from occurring. This is called nitrogen replacement, and one of very important work in brazing refrigerant piping. (Oxidation preventive is not possible to use)

(Work method)

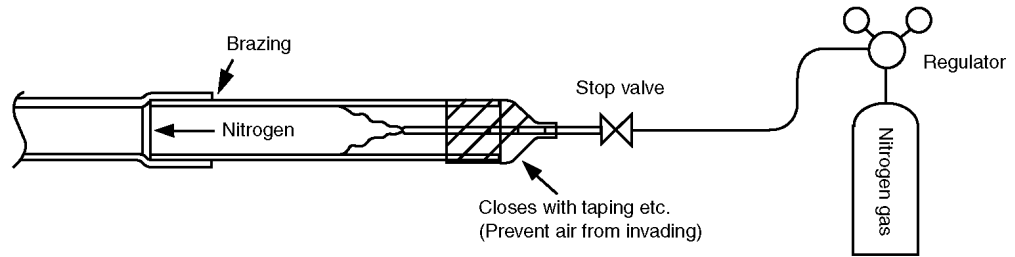

b. Prevention measure for refrigerant piping

Prevention measure for refrigerant piping is very important work to prevent water-dust-rubbish from getting in. All piping terminals needs sealing such as shown below.

Place	Period of work	Method of seal
Outside	More than 1 month	Pinch
	Less than 1 month	Pinch or taping
Inside	Not specified	

– How to pinch

Close terminal part of piping with pliers and seal the gap with brazing.

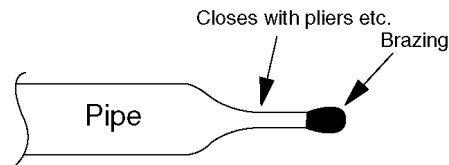

– How to tape

Seal terminal part of piping with vinyl tape.

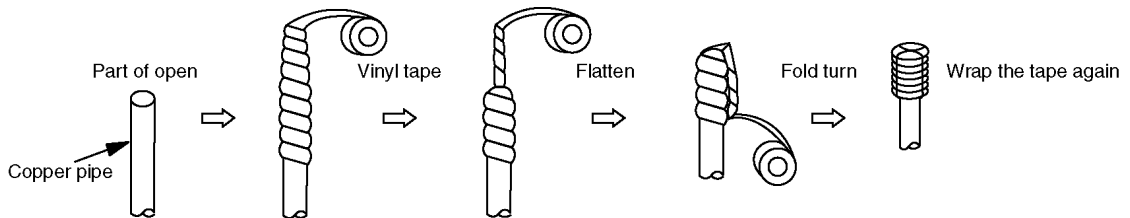

3. Vacuum pumping

The purpose of vacuum pumping work is to remove and dry air inside the piping or nitrogen at air tightness test. Perform the work carefully.

⚠ Caution	Use the vacuum pump with the backflow prevention mechanism to prevent backflow of oil.
------------------	--

Vacuumping time	60 minutes or more
-----------------	--------------------

⚡ Vacuum pump capacity
60 l/min or more

4. Refrigerant filling

Refrigerant filling must be done in the state of liquid refrigerant. If this is done in gas refrigerant, the balance of refrigerant composition will collapse and damage the operation.

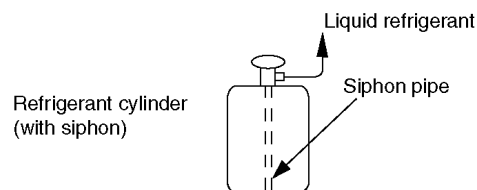

For the use of a gas cylinder without siphon inside, turn it upside down and use it.
(We recommend manifold with sight glass.)

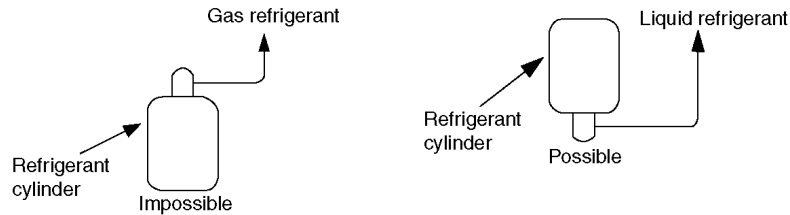

⚠ Caution	Do not use a "CHARGE CYLINDER".
⚠ Caution	As a rule, please collect all existing refrigerants in the system outside the system when the refrigerant leakage occurs by the system. After that, please fill new refrigerant of a regulated amount again.

DRY VACUUMING

- If vacuum pump possible vacuuming until less than -100.7kpa.
 1. Running vacuum pump at both liquid and gas side for more than 1 hour and vacuuming until -100.7kpa.
 2. After that keep the pressure -100.7kpa for 1 hour and confirm the vacuum gauge value not increasing.
 3. If vacuum gauge value is increase, there is possibility of water inside the unit or there is any leakage.

10.3.3. Regarding handling

Handling the unit by hold the handle at compressor side and hold the basepan bottom at fan side.

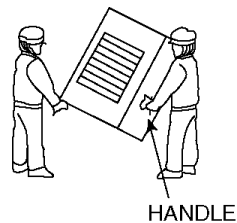

10.3.4. Selecting the outdoor unit installation locations

- Select location which satisfies the following condition, and then confirm with the customer that such a place is satisfactory before installing the outdoor unit.
 1. There should be sufficient ventilation.
 2. The outdoor unit should be sheltered as much as possible from rain and direct sunlight, and the air should be able to move around so that hot and cold air do not build up.
 3. There should not be animals or plants near the air outlet which could be adversely affected by hot or cold air coming out from the unit.
 4. The outlet air and operating noise should not be a nuisance to other occupants nearby.
 5. The location should be able to withstand the full weight and vibration of the outdoor unit, and it should also be level and safe for the unit to be installed.
 6. The intake and outlet should not be covered.
 7. There should not be danger of flammable gas or corrosive gas leaks.
 8. There should be as little back-ventilation (air blowing directly onto the fan) as possible.
(If strong wind blows directly onto the fan, it may cause problems with normal operation.)
 - If you know which direction the prevailing wind comes from during the operating season, set the outdoor unit at a right-angle to this wind direction, or so that air outlet faces toward a wall or fence.
 - If there are obstructions near the outdoor unit and the wind direction is not constant, install an optional air guider.
 9. Do not allow any obstacles near the outdoor unit which will interfere with air flow around the air intake and air outlet.
 10. If installing in a location which is prone to snowfall, place the installation base as high as possible, and be sure to install a roof or enclosure which does not allow snow to accumulate.
 11. Avoid installing the unit in places where petroleum products (such as machine oil), salinity, sulphurous, gases or high-frequency noise are present.

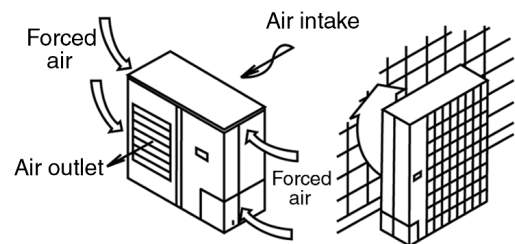

12. Be sure to leave enough space around the outdoor unit to maintain proper performance and to allow access for routine maintenance.
- Allow enough space from any obstacles as shown in Fig. 1.2 below in order to prevent short-circuits from occurring.

(If installing more than one outdoor unit, make the necessary space available as outlined in 13.)

However, there should be at least 1 meter of free space above the unit.

- The height of any obstacles at the air intake and outlet sides should not be greater than the height of the outdoor unit.
- When facing the air intake side toward a wall.

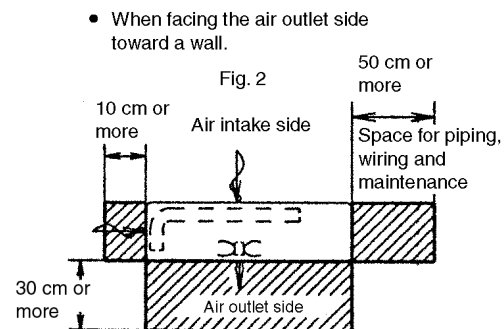
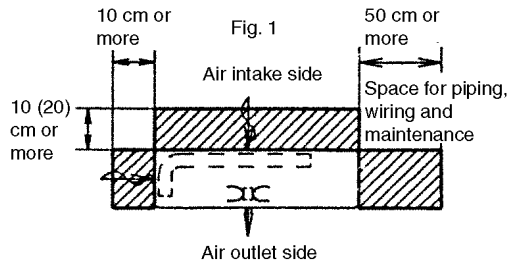

13. If installing more than one outdoor unit, allow enough space around each unit as shown below.

- When installing units side by side

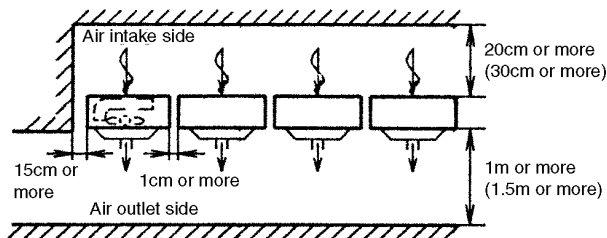

- When installing units facing each other

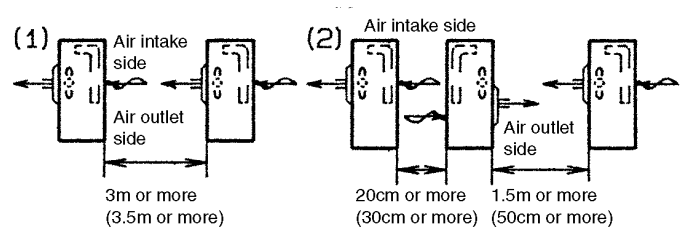

✕ Maintain sufficient space above the unit.

Values inside brackets indicate distances when installing the 4HP - 6HP.

- The distance given above are the minimum distance required in order to maintain proper performance. Allow as much space as possible in order to get the best performance from the units.

10.3.5. Transporting and installing the outdoor unit

- Transporting

1. The outdoor unit should be transported in its original packaging as close to the installation location as possible.
2. If suspending the outdoor unit, use a rope or belt, and use cloth or wood as padding in order to avoid damaging the unit.

- Installation

1. Read the "Selecting the outdoor unit installation location" section thoroughly before installing the outdoor unit.
2. If installing the unit to a concrete base or other solid base, use M10 or W3/8 bolts and nuts to secure the unit, and ensure that the unit is fully upright and level.

(The anchor bolt positions are shown in the diagram at the right side.)

In particular, install the unit at a distance from the neighbouring building which conforms to regulations specified by local noise emission regulation standards.

3. Do not install the outdoor unit to the building's roof.
4. If there is a possibility that vibration may be transmitted to the rooms of the building, place rubber insulation between the unit and the installation surface.
5. Drain water will be discharged from the outdoor unit when operating the system in heating or defrosting modes. Select an installation location which will allow the water to drain away properly, or provide a drainage channel so that the water can drain away.

(If this is not done, the drain water may freeze during winter, or the water may spill down to areas underneath the installation location.)

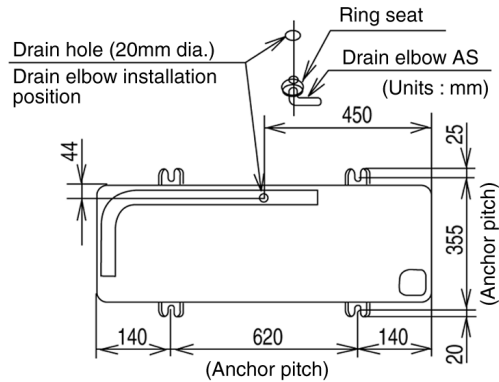

- If a drain pipe needs to be installed, insert the accessory drain elbow into the mounting hole at the bottom of the outdoor unit, and connect a hose with an inside diameter of 15mm to this drain elbow.

(The hose is not supplied.)

⊗ If using the drain elbow, install the outdoor unit on a base which is at least 5cm high.

NOTE In cold regions (where the outdoor air temperature can drop to 0°C or below continuously for 2-3 days), the drain water may freeze, and this may prevent the fan from operating. Do not use the drain elbow in such cases.

10.3.6. Connecting the pipes

- Use a clean pipe which does not include water or dust for inside of piping.
- When cutting the refrigerant pipes, a piping cutter must be used. Before connecting the refrigerant pipes, blow nitrogen and blow off dust in the pipes.
(Never use tools which cause a lot of dust such as a saw and a magnet.)
- When waxing replace nitrogen inside the piping after removing dirt and dust. (In order to prevent oxidization scale from forming inside the piping).
- The refrigerant pipes are of particular importance.
The installation work for refrigerant cycles in separate-type air conditioners must be carried out perfectly.

1. Refer to the table below for the pipe diameters equivalent lengths and indoor/outdoor unit difference of elevation.

Pipe diameter (mm)		Equivalent length (m)	Difference of elevation (m)
Liquid-side pipes	Gas-side pipes		
ø9.52 x 0.8	ø15.88 x 1.0	50	30

2. Local pipes can project in any of four directions.

- Make holes in the pipe panels for the pipes to pass through.
- Be sure to install the pipe panels to prevent rain from getting inside the outdoor unit.

[Removing the service panel].

- (1) Remove the two mounting screws.
- (2) Slide the service panel downward to release the pawls. After this, pull the service panel toward you to remove it.

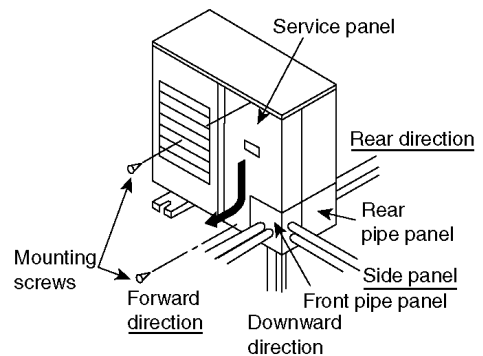

3. Notes when connecting the refrigerant pipes.

- Use clean copper, pipes with no water or dust on the insides.
- Use phosphorus-free, unjointed copper pipes for the refrigerant pipes.
- If it is necessary to cut the refrigerant pipes, be sure to use a pipe cutter, and use compressed nitrogen or an air blower to clean out any foreign particles from inside the pipe.
- Be careful not to let any dust, foreign materials or water get inside the pipes during connection.
- If bending the pipes, allow as large a bending radius as possible. Do not flex the pipes any more than necessary.
- If joining pipe ends, do so before tightening the flare nut.
- Always blow the pipe end with nitrogen while joining pipe ends.
(This will prevent any oxide scaling from occurring inside the pipe.)
- If using long pipe lengths with several joined pipe ends, insert strainers inside the pipes. (Strainers are not supplied.)
- When tightening the flare nuts, coat the flare (both inside surfaces) with a small amount of refrigerator oil, and screw in about 3-4 turns at first by hand.
- Refer to the following table for the tightening torques. Be sure to use two spanners to tighten.
(If the nuts are overtightened, it may cause the flares to break or leak.)

Flare nut fastening torque N•m (kgf•cm)			
ø6.35 mm	18 (180)	ø15.88 mm	65 (660)
ø9.52 mm	42 (430)	ø19.05 mm	100 (1020)
ø12.7 mm	55 (560)		

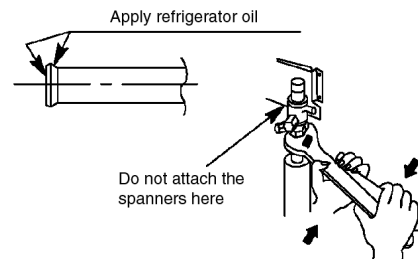

4. After piping connection has been completed, make sure that the joint areas of the indoor and outdoor units are free from gas leakage by the use of nitrogen, etc.
5. Air purge within connection piping shall be carried out by evacuation.
6. Close the tube joining area with putty heat insulator (local supply) without any gap as shown in below figure.
(To prevent insects or small animal entering)

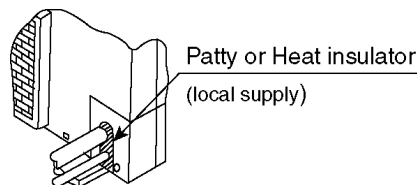

10.3.7. Heat insulation

⚠ Caution	Use a material with good heat-resistant properties as the heat insulation for the pipes. Be sure to insulate both the gas-side and liquid-side pipes. If the pipes are not adequately insulated, condensation or water leakages may occur.
-----------	--

Liquid-side pipes	Material that can withstand 120°C or higher
Gas-side pipes	

10.3.8. Charging with refrigerant

- At the time of shipment from the factory, this unit is charged with enough refrigerant for an equivalent pipe length of 30m. If the equivalent pipe length used will be 30m or less, no additional charging will be necessary.
- If the equivalent pipe length will be between 30 and 50m, charge with additional refrigerant according to the equivalent length given in the table below.
– For standard type

Additional charging amount	Equivalent length
0.05 kg/m	50m

- Pump down operation
 - Operate the pump down according to the following procedures.

Procedure	Notes
1. Confirm the valve on the liquid side and the gas side is surely open.	
2. Press the PUMP DOWN switch on outdoor printed board for 1 second or more.	Perform the cooling operation for five minutes or more.
3. Shut the valve on the liquid side surely.	When the valve is shut halfway, the compressor is occasionally damaged.

10.3.9. Electrical wiring

⚠ Warning	The units must be connected to the supply cables for fixed wiring by qualified technician. Feed the power source to the unit via a distribution switch board designed for this purpose, the switch should disconnected all poles with a contact separation of at least 3mm. When the supply cable is damaged, it must be replaced by qualified technician.
⚠ Caution	Be sure to install a current leakage breaker, main switch and fuse to the main power supply, otherwise electric shocks may result.
⚠ Caution	Be sure to connect the unit to secure earth connection. If the earthing work is not carried out properly, electric shocks may result.
⚠ Warning	Wiring shall be connected securely by using specified cables and fix them securely so that external force of the cables may not transfer to the terminal connection section. Imperfect connection and fixing leads to fire, etc.

- Connect the power supply wiring and indoor/outdoor unit connection wiring according to the electrical circuit diagram instructions.
- Clamp the wires securely to the terminal connections using cord clamps so that no undue force is placed on the wires.
- Once all wiring work has been completed, tie the wires and cords together with the binding strap so that they do not touch other parts such as the compressor and pipes.

1. Connect the power supply line to a 3-phase/380-415V (or single-phase 220-240V) power supply.
2. The equipment shall be connected to a suitable mains network with a main impedance less than the value indicated in the table of power supply specifications.
3. Be sure to connect the wires correctly to terminal board with connecting the crimp type ring terminal to the wires.
4. The binding screws inside the power supply box may become loosened due to vibration during transportation, so check that they are tightened securely.
5. Tighten the binding screws to the specified torque while referring to the table below.
6. If connecting two separate wires to a single crimped terminal, place the two crimped terminal wires together as shown in Fig. A. (If the arrangement shown in Fig. B is used, poor contacts or contact damage may result.)
7. If momentarily turning on the power supply for both the indoor and outdoor units, do not turn the power off again until at least 1 minute has passed (except when a reversed phase has been detected).

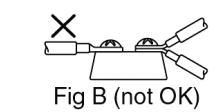
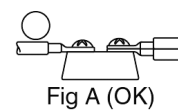
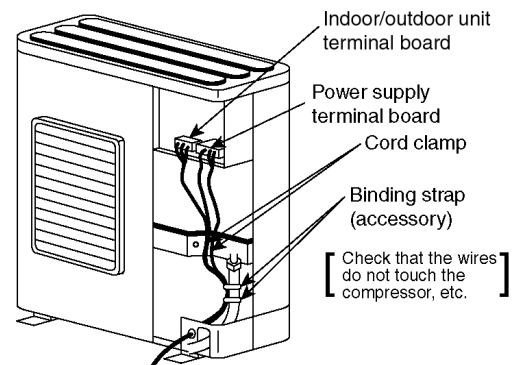

⚠ Warning	Use only the specified cables for wiring connections. Connect the cable securely, and secure them properly so that no undue force will be applied to the terminal connections. If the terminals are loose or if the wires are not connected securely, fire may result.
-----------	---

Terminal screw	Tightening torque N.cm {kgf.cm}
M3	69 ~ 98 {7 ~ 10}
M4	157 ~ 196 {16 ~ 20}
M5	196 ~ 245 {20 ~ 25}

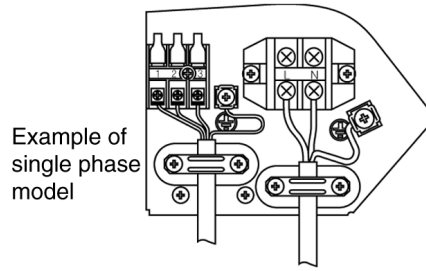

Earth lead wire shall be longer than other lead wires as shown in the figure for the electrical safety in case of the slipping out of the cord from the anchorage.

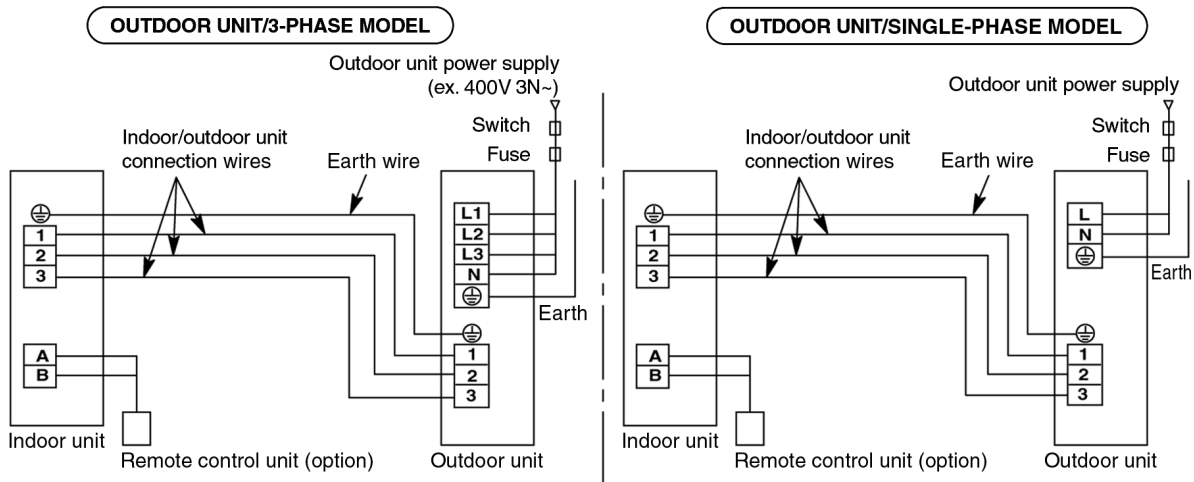

• Power supply specifications

Model name	Leakage current breaker (A)	Circuit breaker (Minimum Capacity)		Minimum power supply cables	4mm ² cable based on length (m)	Maximum permissible impedance (Ω)	Indoor/outdoor unit connection
		Switch (A)	Fuse (A)				power cables (terminals ①, ②, ③, ⊕)
CU-L24DB***	220V-240V~	30	30	20	4 mm ²	14	2.5 mm ² × 3
CU-L28DB***	220V-240V~	30	30	20		14	
CU-L34DB***	220V-240V~	40	40	30		9	
CU-L43DB***	220V-240V~	40	40	40		8	
CU-L50DB***	380V-415V 3N~	30	30	30		11	

NOTE



- Where ground work (earth) is carried out, do not connect the ground return to the gas pipe, water line pipe, grounded circuit of the telephone and lightning rod, or ground circuit of other product in which earth leakage breaker is incorporated. (Such action is prohibited by statute, etc.)

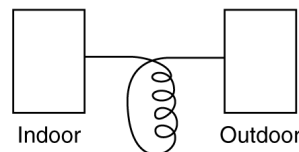

Make sure the indoor and outdoor connection wires are detangled. (There might be effect to received outside noise.)

- Use the standard power supply cables for Europe (such as H05RN-F or H07RN-F which conforms to GENELEC (HAR) rating specifications) or use the cables based on IEC standard. (245IEC57, 245IEC66)
- Select the particular size of electrical wire for power supply cables in accordance with the standards of the given nation and region.

10.3.10. Connecting power supply cables

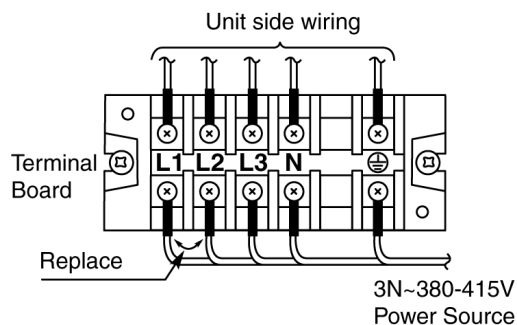

CAUTION

- For three phase model, never operate the unit by pressing the electromagnetic switch.
- Never correct the phase by switching over any of the wires inside the unit.

10.3.11. Precautions with regard to test operation

CAUTION

- Always be sure to use a properly-insulated tool to operate the switch on the circuit board. (Do not use your finger or a metallic object.)
- Never turn on the power supply until all installation work has been completed.
- Turn on the circuit breaker 12 hours or more before a test run. (By supplying power to crankcase heater, compressor is warmed and liquid compressing is prevented.)
- Check that the voltage is 90% of rated voltage or higher when starting the unit.
(The unit will not operate if the voltage is less than 90% of rated voltage.)
- Test operation can be carried out using the remote control unit or by using the switch on the printed circuit board inside the outdoor unit.

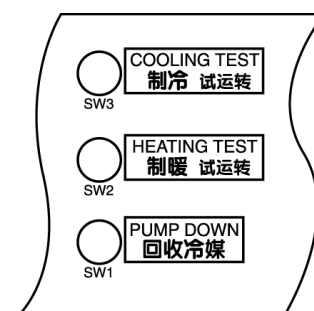

If carrying out test operation at the printed circuit board of the outdoor unit, follow the procedure given below. (If using the remote control unit to carry out test operation, refer to the installation manual which is supplied with the indoor unit.)

- Press the COOL or HEAT switch for 1 second or more.
(Be sure to select cooling mode first, and run the units in this mode for 5 minutes or more.)
- Press the TEST button once more to cancel test operation mode.
- When performing heating test operation when the outside temperature is high, or cooling test operation when the outside temperature is low, the protection circuits may sometimes operate within a few minutes.

NOTE 1

These units are equipped with connection error prevention circuits. If the units do not operate, it is possible that the connection error prevention circuits have been operated. In such cases, check that the Indoor/outdoor unit connection wire (connected to terminals ①, ② and ③) is connected correctly. If they are connected incorrectly, connect them correctly. Normal operation should then commence.

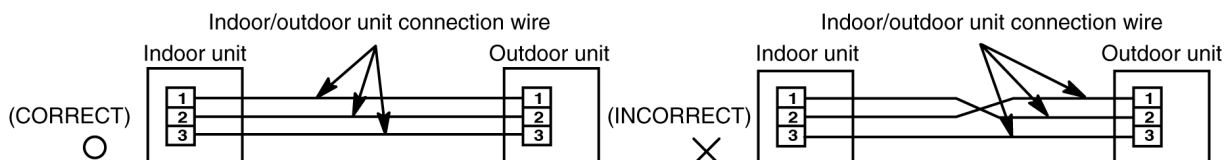

NOTE 2

Do not short the remote control unit wires to each other. (The protection circuit will be activated and the units will not operate.) Once the cause of the short is eliminated, normal operation will then be possible.

NOTE 3

When running the units in heating mode during test operation, be sure to run the units in cooling mode first before selecting this mode. If heating mode is selected first, it may cause problems with operation of the compressor.

NOTE 4

Test operation should be carried out for a minimum of 5 minutes. (Test operation will be cancelled automatically after 30 minutes.)

NOTE 5

Test operation mode should always be cancelled once test operation itself has been completed.

NOTE

If the self-diagnosis function reports a problem but more than one problem has developed at the indoor and/or outdoor units, the problem display on the remote control unit may not match the LED display on the outdoor unit printed circuit board. In such cases, check both locations and remove the causes of the problems.

10.3.12. As to making the inspection after completion of work fully understood

- At the time when the work has been completed, measure and record the characteristics of test run without fail and keep the measuring date, etc.
- Carry out the measurement regarding room temperature outside air temperature, suction and air discharge temperatures, wind velocity, wind volume, voltage current, presence of abnormal vibration, operating pressure, piping temperature, compressive pressure, airtight pressure as items to be measured.
- As to the structure and appearance, check following items.

- Short circuit of the blow-out air
- Smooth flow of the drain
- Reliable thermal insulation
- Leakage of refrigerant

- Mistake in wiring
- Reliable connection of the grand wire
- Looseness in terminal screw, fastening torque

M3... 69-98N.cm {7-10kgf.cm} M4... 157-196N.cm {16-20kgf.cm}
M5... 196-245N.cm {20-25kgf.cm}

10.3.13. As to delivery to the customer





- Request the customer to operate this air conditioner viewing instruction manual come with indoor unit in practice and explain how to operate.
- Deliver the instruction manual to the customer without fail.

10.4. Wired remote controller installation

Wired Remote Controller Installation Manual

- Before installing the wired remote controller, be sure to thoroughly read the “Notes with regard to safety” section of the installation manual provided with the indoor unit.
- After installing the wired remote controller, carry out a test operation to check that the remote controller functions properly, and also explain the operation and cleaning procedures to the customer in accordance with the details in instruction manual. Furthermore, ask the customer to keep this installation manual and the instruction manual in a safe place for later reference.

10.4.1. Accessories supplied with wired remote controller

Name	Q'ty	Diagram	Remark
Remote controller	1		
Remote control cable	1		Length (10m)
4mm screw	3		Installing the remote controller to the wall
M4 screw	3		Installing the remote controller to an outlet box
Round terminal	2		Connecting to indoor unit terminal block

10.4.2. Notes regarding wired remote controller setting-up location

- Select a place where the remote controller can be operated easily (after obtaining approval from the building's owner).
- Install in a place which is away from direct sunlight and as free from humidity as possible.
- Install in a place which is as flat as possible to avoid warping of the remote controller.
(If installed to a wall an uneven surface, damage to the LCD case or operation problems may result.)
- Install in a place where the LCD can be seen easily. If the remote controller is installed somewhere which is too low or too high, it may be difficult to read the LCD. (Standard height from the floor is 1.2 to 1.5 meters.)
- Avoid installing the remote control cable near refrigerant pipes or drain pipes.
- Install the remote control cable at least 5cm away from other electric wires (including stereo and TV cables) to avoid mis-operation (electromagnetic noise).
- If passing the remote control cable through a wall, be sure to install a water trap above the cable.
- Allow sufficient space around the remote controller as shown in the illustration at below.
Secure the remote controller lower case to the wall or to an outlet.

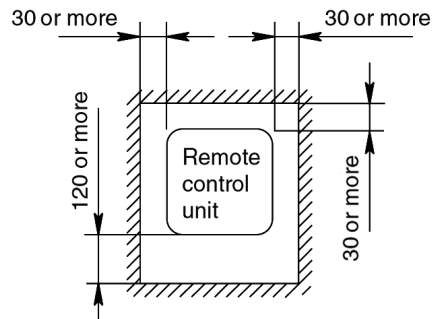

10.4.3. Remote controller installation

- Be sure to turn off the main power before installing and connecting the remote controller.
(If the remote controller is connected while the power is still turned on, the remote controller displays may not appear.)
If no displays appear on the remote controller, check while referring to "If no remote controller displays appear" in "9.5.5. Test operation".
- The remote control cable is live during use, so please be careful with it.

Remote controller wiring

- Connect the indoor unit and the remote controller as shown in the illustration below.
- The remote control cable is non-polar.
- At the time of shipment from the factory, the connector cable used to connect the terminal block and connector CN1 is disconnected. When connecting the remote controller wiring and installing the remote controller, be sure to connect the cord to the connector CN1.

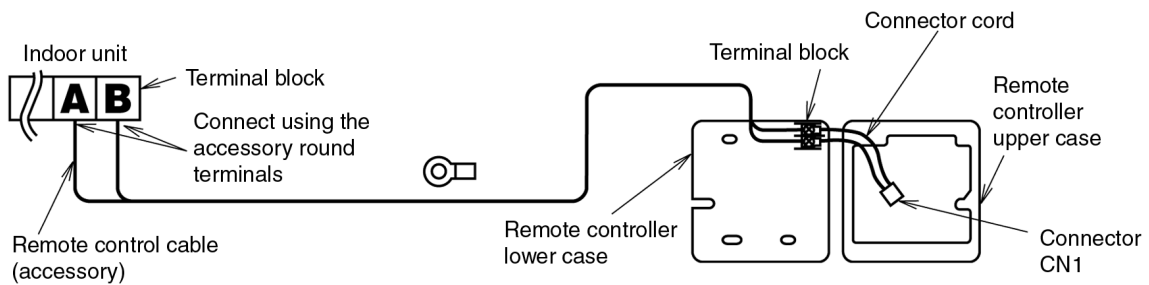

Extending the remote control cable

- Solder a sheathed PVC cord or cable (0.5 - 2 mm²) with specifications among those given below to the remote controller end of the accessory remote control cable (10 m).

* PVC round cable cord	IEC 502
* 600V PVC-insulated PVC sheathed round cable	IEC 227-4
* 600V PVC-insulated PVC sheathed flat cable	IEC 227-4

NOTE The maximum possible length for the remote control cable is 200 m.

Remote controller installation procedure

- Remove the remote controller lower case.
(Insert a flat-tipped screw driver or similar 2 to 3 mm into one of the gaps at the bottom of the case, and then twist the screw driver to open. [Refer to the illustration below.])
Be careful not to damage the lower case.

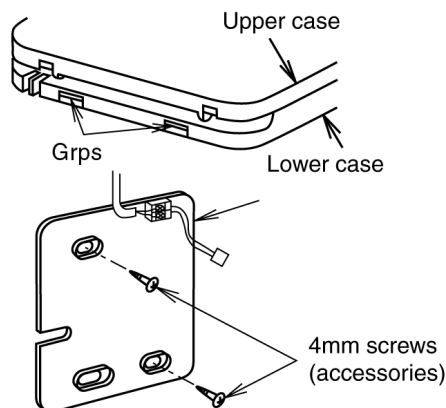

- Secure the lower case to the wall or outlet box.
(Refer to the illustration below for the embedded and exposed positions for remote control cable.)

NOTE

- Be sure to use only the accessory screws.
- Do not bend the lower case when tightening the screws.
(If the screws are overtightened, damage may result.)
- Do not remove the protective tape which is affixed to the upper case circuit board.
- If installing the remote controller with the remote control cable exposed, use nippers to cut a notch into the upper case. (The feeding-out direction can be either up or to the left or right)
- Strip the end of the remote control cable which is to be connected to the remote controller. (Refer to the illustration below)

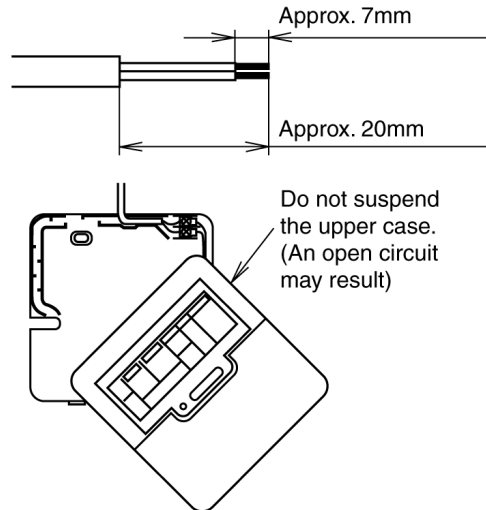

- Route the remote control cable inside the lower case in accordance with the intended feeding-out direction. (Refer to the illustration below.)

Securely connect connector CN1. (If it is not connected, the remote controller will not operate.)

- NOTE** After connecting the connector, do not suspend the upper case by its own weight, otherwise the connector cord may break.

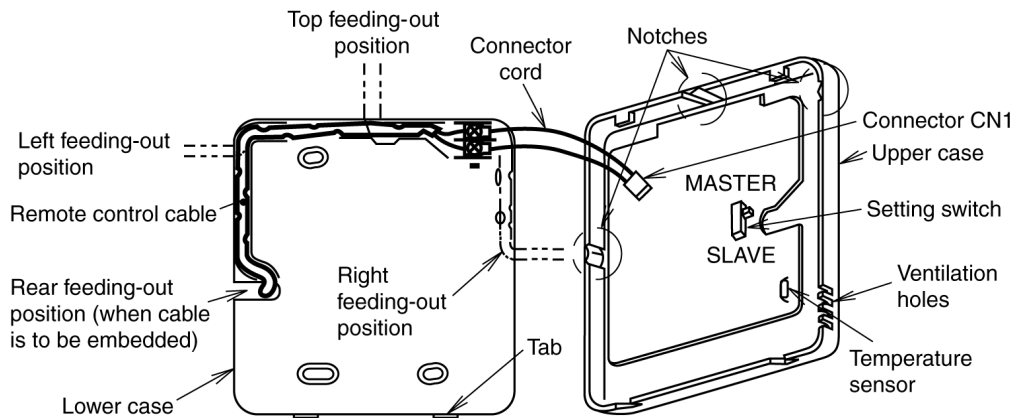

- If controlling using two remote controllers, refer to "Control using two remote controller-s" in "9.4.4. Settings".
- Secure the upper case to the lower case.

(Hook the upper tab of the upper case into the lower case, and then push the upper case until it snaps shut onto the lower case tab, while being careful not to clamp the remote control cable and the connector cord.)

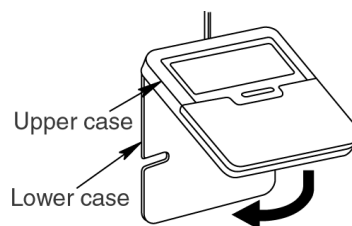

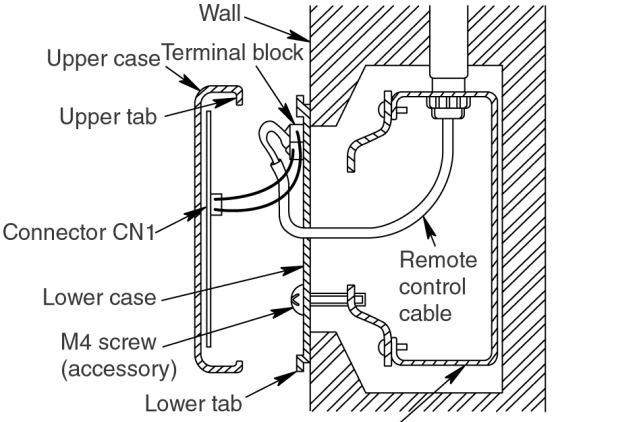
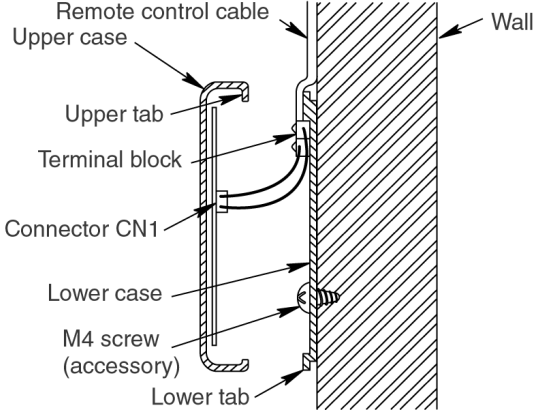
If remote control cable is embedded	If installing with the remote control cable exposed
<p>1. Embed an outlet box (JIS C 8336) into the wall, and then secure the remote controller base plate to the outlet box with the two accessory M4 screws. Make sure that the base plate is flat against the wall at this time, with no bending (looseness)</p> <p>2. Pass the remote control cable into the box and then install the remote controller.</p>  <p>Medium-sized square outlet box (JIS C 8336) (obtain locally) Part No. DS3744 (Matsushita Electric Industrial Co., Ltd.) or equivalent</p>	<p>1. Secure the remote controller base plate to the wall with two accessory 4 mm screws.</p> <p>2. The feeding-out direction for the remote control cable can be either up or to the left or right. (Refer to the illustration at left.) After determining the feeding-out direction, use nippers to make a notch in the cover.</p> <p>3. Route the remote control cable as shown in the illustration at left. Pull the cord firmly around the outside of the base plate at this time.</p> 

10.4.4. Settings

Control using two remote controllers

- Up to two remote controllers can be installed for a single indoor unit, and either remote controller can be used to operate the indoor unit.
- The indoor unit can be operated with the last switch pressed having priority.

1. Decide which is to be the master and which is to be the slave remote controller.

The master or slave states of the remote controller are set automatically. The MASTER/SLAVE setting switch can also be used to make the setting manually, however if a manual setting is made, that manual setting has priority.

Be sure to turn off the main power before making a manual setting.

2. Connect the remote controllers.

Connect both remote controllers to terminals (A) and (B) on the indoor unit terminal block (non-polar).

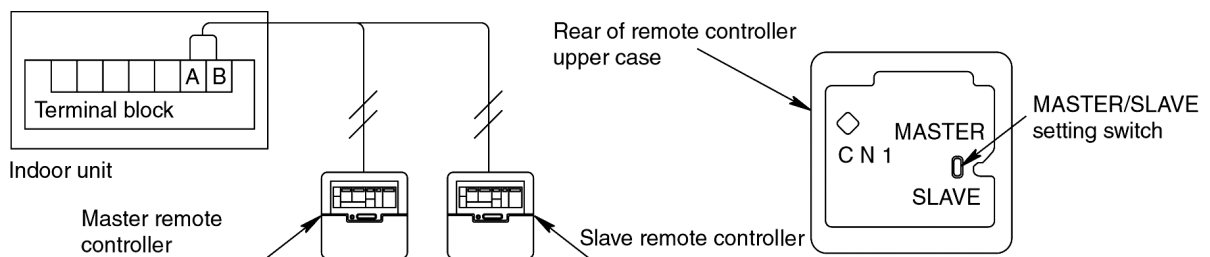

Group control

- All in group will be remote controller thermistor setting when using the remote controller thermistor.
- Up to a maximum of 16 indoor units can be connected at the time of group control.
(Do not connect heat pump unit with cooling only unit.)
- Indoor unit No. is possible to set automatically at the time of group control. However, what number would be assigned to which indoor units is unknown.

Indoor unit No. is also possible to set manually with DIP switches. Since manual address setting is priority during performing automatic address setting. (Do not use manual address setting and automatic address setting together.)

[Manual Setting]

Indoor unit No.	1	2	3	4	5	6	7	8
DIP switch (SW2) address setting on indoor unit printed circuit board.								
A/C No. setting	Unnecessary operation	1 - ON	2 - ON	1, 2 - ON	3 - ON	1, 3 - ON	2, 3 - ON	1, 2, 3 - ON
Indoor unit No.	9	10	11	12	13	14	15	16
DIP switch (SW2) address setting on indoor unit printed circuit board.								
A/C No. setting	4 - ON	1, 4 - ON	2, 4 - ON	1, 2, 4 - ON	3, 4 - ON	1, 3, 4 - ON	2, 3, 4 - ON	1, 2, 3, 4 - ON

Automatic address resetting for group control

- The address settings for group control (air conditioner Nos. 1 to 16) can be reset automatically.
 - When operation is stopped, press for 5 seconds, continue the TEST RUN switch to display "00" (will be LOCAL MODE).
 - Press the UP (TEMP) DOWN (TEMP) switch to display 10.
 - Press the SELECT switch to display "000". It would blinks.
 - Press the UP (TIMER) DOWN (TIMER) switch to display "001". It would blinks.
 - Press the SET switch.

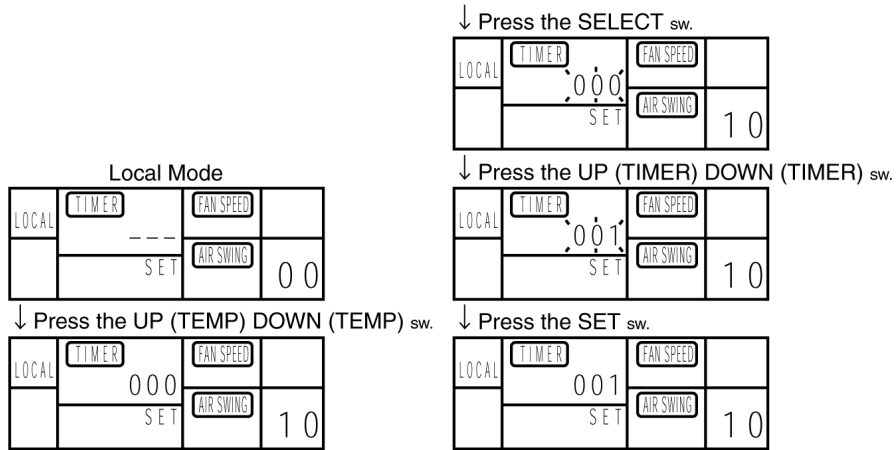

Switching the thermistor

- The temperature detection thermistor can be switched between the thermistor at the indoor unit and the thermistor at the remote controller. However, do not switch to the remote controller thermistor if using two remote controllers.
 - When operation is stopped, press for 5 seconds, continue the TEST RUN switch to display "00" (will be LOCAL MODE).
 - Press the UP (TEMP) DOWN (TEMP) switch to display 11.
 - Press the SELECT switch to display "000". It would blinks.
 - Press the UP (TIMER) DOWN (TIMER) switch to choose display "000" or "001".
 - "000"... Indoor unit setting (factory default)
 - "001"... Remote controller setting
 - Press the SET switch. (Be sure to press the SET switch so that normal operation mode can be resumed.)
- Repeat the procedure in steps (1) to (5) to change the setting again.

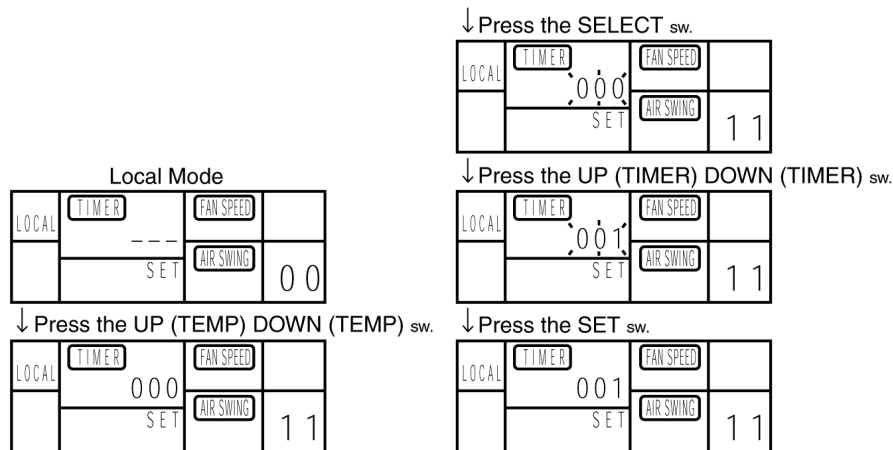

10.4.5. Test operation

- Turn on the main power.
- After 3 minutes have passed since the power was turned on, press the OFF/ON switch on the remote controller. (No operation occurs within 3 minutes after the power was turned on.)
- Press the TEST RUN switch within 1 minute of pressing the OFF/ON switch.
- Next, select the operation mode. (Be sure to select cooling mode first, and run the unit in this mode for 5 minutes or more.)
- Press the OFF/ON switch or the TEST RUN switch to cancel test operation.
- Test operation will be cancelled automatically after 30 minutes.



If remote controller displays nothing

- Check once more that the remote control cable is securely connected. (Check for loose terminals, poor contacts, connection positions terminal block, etc.)
- If the above checks show that nothing is wrong but nothing appears on the remote controller display.
- It is possible that the remote controller was connected while the main power was still turned on. If such is the case, carry out the following.

*Set DIP switch (SW2) No. 1 to 4. The ON position, and then turn on the main power. If the display appears after about 30 seconds, turn DIP switches 2 to 4 to OFF position.

10.4.6. Self-diagnosis function

If "CHECK" is blinking on the timer

- If the "CHECK" display on the wired remote controller is blinking, the details of the problems are displayed on the timer display screen each time the CHECK switch is pressed.
- Further details of the problem can be displayed by pressing the SET switch while the general problem details are being displayed.

Example of current problem display

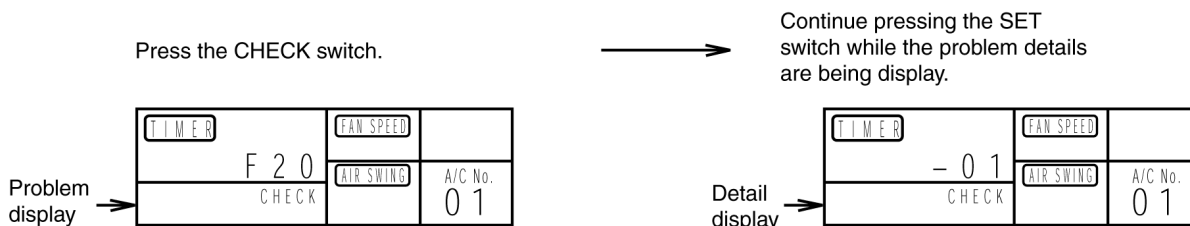

If "CHECK" is not blinking on the timer

- If the "CHECK" display on the wired remote controller is not blinking, press the CHECK switch continuously for 5 seconds or more to display the problem details for the last problem or the problem before that.

- You can then switch between the display for the previous problem and the problem before that by pressing the UP (TIMER) DOWN (TIMER) switches.
- Press the CHECK switch once more to return to the normal display.

Example of previous problem display

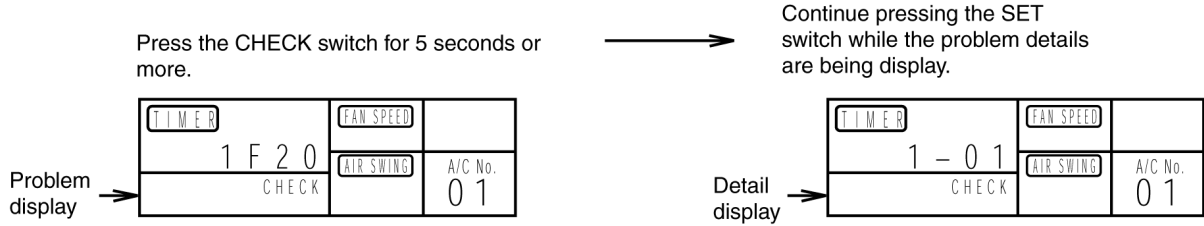

Example of abnormality display before previous display

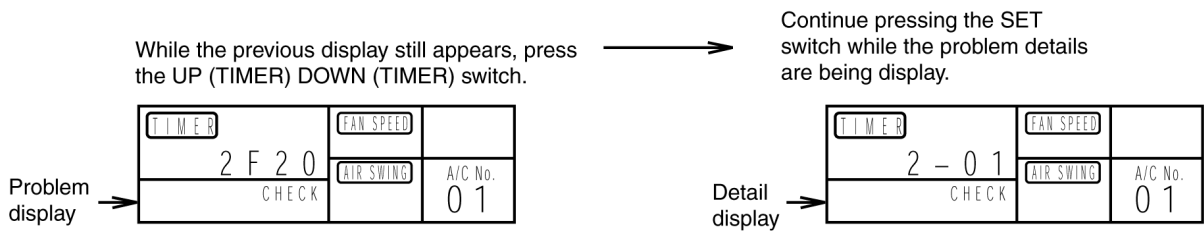

- The display can be switched between the previous problem and the one before that by pressing the UP (TIMER) DOWN (TIMER) switches.
- After eliminating the cause of the problem, press the CHECK switch once more to return to the normal display.

11 INSTALLATION & SERVICING AIR CONDITIONER

11.1. Outline

11.1.1. About R410A refrigerant

1. Converting air conditioners to R410A

Since it was declared in 1974 that chlorofluorocarbons (CFC), hydro chlorofluorocarbons (HCFC) and other substances pose a destructive danger to the ozone layer in the earth's upper stratosphere (20 to 40 km above the earth), measures have been taken around the world to prevent this destruction.

The R22 refrigerant which has conventionally been used in ACs is an HCFC refrigerant and, therefore, possesses this ozone-destroying potential. International regulations (the Montreal Protocol on Ozone-Damaging Substances) and the domestic laws of various countries call for the early substitution of R22 by a refrigerant which will not harm the ozone layer.

- In ACs, the HFC refrigerant which has become the mainstream alternative is called R410A. Compared with R22, the pressure of R410A is approximately 1.6 times as high at the same refrigerant temperature, but the energy efficiency is about the same. Consisting of hydrogen (H), fluorine (F) and carbon (C), R410A is an HFC refrigerant. Another typical HFC refrigerant is R407C. While the energy efficiency of R407C is somewhat inferior to that of R410A, it offers the advantage of having pressure characteristics which are about the same as those of R22, and is used mainly in packaged ACs.

2. The characteristics of HFC (R410A) refrigerants

a. Chemical characteristics

The chemical characteristics of R410A are similar to those of R22 in that both are chemically stable, non-flammable refrigerants with low toxicity.

However, just like R22, the specific gravity of R410A gas is heavier than that of air. Because of this, it can cause an oxygen deficiency if it leaks into a closed room since it collects in the lower area of the room. It also generates toxic gas when it is directly exposed to a flame, so it must be used in a well ventilated environment where it will not collect.

Table 1 Physical comparison of R410A and R22

	R410A	R22
Composition (wt%)	R32/R125 (50/50)	R22 (100)
Boiling point (°C)	-51.4	-40.8
Vaporizing pressure (25°C)	1.56 Mpa (15.9 kgf/cm ²)	0.94 Mpa (9.6 kgf/cm ²)
Saturated vapor density	64.0 kg/m ³	44.4 kg/m ³
Flammability	Non-flammable	Non-flammable
Ozone-destroying point (ODP)	0	0.055
Global-warming point (GWP)	1730	1700

b. Compositional change (pseudo-azeotropic characteristics)

R410A is a pseudo-azeotropic mixture comprising the two components R32 and R125. Multi-component refrigerants with these chemical characteristics exhibit little compositional change even from phase changes due to vaporization (or condensation), which means that there is little change in the circulating refrigerant composition even when the refrigerant leaks from the gaseous section of the piping.

Accordingly, R410A can be handled in almost the same manner as the single-component refrigerant R22. However, when charging, because there is a slight change in composition between the gas phase and the liquid phase inside a cylinder or other container, charging should basically begin with the liquid side.

c. Pressure characteristics

As seen in Table 2, the gas pressure of R410A is approximately 1.6 times as high as that of R22 at the same refrigerant temperature, which means that special R410A tools and materials with high-pressure specifications must be used for all refrigerant piping work and servicing.

Table 2 Comparison of R410A and R22 saturated vapor density

Refrigerant Temperature (°C)	Unit: MPa	
	R410A	R22
-20	0.30	0.14
0	0.70	0.40
20	1.35	0.81
40	2.32	1.43
60	3.73	2.33
65	4.15	2.60

d. R410A refrigerating machine oil

Conventionally, mineral oil or a synthetic oil such as alkylbenzene has been used for R22 refrigerating machine oil. Because of the poor compatibility between R410A and conventional oils like mineral oil, however, there is a tendency for the refrigerating machine oil to collect in the refrigerating cycle. For this reason, polyester and other synthetic oils which have a high compatibility with R410A are used as refrigerating machine oil.

Because of the high hygroscopic property of synthetic oil, more care must be taken in its handling than was necessary with conventional refrigerating machine oils. Also, these synthetic oils will degrade if mixed with mineral oil or alkylbenzene, causing clogging in capillary tubes or compressor malfunction. Do not mix them under any circumstances.

11.1.2. Safety measures when installing/servicing refrigerant piping

Cause the gas pressure of R410A is approximately 1.6 times as high as that of R22, a mistake in installation or servicing could result in a major accident. It is essential that you use R410A tools and materials, and that you observe the following precautions to ensure safety.

1. Do not use any refrigerant other than R410A in ACs that have been used with R410A.
2. If any refrigerant gas leaks while you are working, ventilate the room. Toxic gas may be generated if refrigerant gas is exposed to a direct flame.
3. When installing or transferring an AC, do not allow any air or substance other than R410A to mix into the refrigeration cycle. If it does, the pressure in the refrigeration cycle can become abnormally high, possibly causing an explosion and/or injury.
4. After finishing the installation, check to make sure there is no refrigerant gas leaking.
5. When installing or transferring an AC, follow the instructions in the installation instructions carefully. Incorrect installation can result in an abnormal refrigeration cycle or water leakage, electric shock, fire, etc.
6. Do not perform any alterations on the AC unit under any circumstances. Have all repair work done by a specialist. Incorrect repairs can result in a water leakage, electric shock, fire, etc.

11.2. Tools for installing/servicing refrigerant piping

11.2.1. Necessary tools

In order to prevent an R410A AC from mistakenly being charged with any other refrigerant, the diameter of the 3-way valve service port on the outdoor unit has been changed. Also, to increase its ability to withstand pressure, the opposing dimensions have been changed for the refrigerant pipe flaring size and flare nut. Accordingly, when installing or servicing refrigerant piping, you must have both the R410A and ordinary tools listed below.

Table 3 Tools for installation, transferring or replacement

Type of work	Ordinary tools	R410A tools
Flaring	Flaring tool (clutch type), pipe cutter, reamer	Copper pipe gauge for clearance Adjustment, flaring tool (clutch type)*1)
Bending, connecting pipes	Torque wrench (nominal diameter 1/4, 3/8, 1/2). Fixed spanner (opposing sides 12 mm, 17 mm, 19 mm). Adjustable wrench, Spring bender	
Air purging	Vacuum pump. Hexagonal wrench (opposing sides 4 mm)	Manifold gauge, charging hose, vacuum pump adaptor
Gas leak inspection	Gas leak inspection fluid or soapy water	Electric gas leak detector for HFC refrigerant*2)

*1) You can use the conventional (R22) flaring tool. If you need to buy a new tool, buy the R410A type.

*2) Use when it is necessary to detect small gas leaks.

For other installation work, you should have the usual tools, such as screwdrivers (+,-), a metal-cutting saw, an electrical drill, a hole core drill (65 or 70 dia.), a tape measure, a level, a thermometer, a clamp meter, an insulation tester, a voltmeter, etc.

Table 4 Tools for serving

Type of work	Ordinary tools	R410A tools
Refrigerant charging		Electronic scale for refrigerant charging. Refrigerant cylinder. Charging orifice and packing for refrigerant cylinder
Brazing (Replacing refrigerating cycle part*1)	Nitrogen blow set (be sure to use nitrogen blowing for all brazing), and brazing machine	

*1) Always replace the dryer of the outdoor unit at the same time. The replacement dryer is wrapped in a vacuum pack. Replace it last among the refrigerating cycle parts. Start brazing as soon as you have opened the vacuum pack, and begin the vacuuming operation within 2 hours.

11.2.2. R410A tools

1. Copper tube gauge for clearance adjustment
(used when flaring with the conventional flaring tool (clutch type))

- This gauge makes it easy to set the clearance for the copper tube to 1.0-1.5 mm from the clamp bar of the flaring tool.

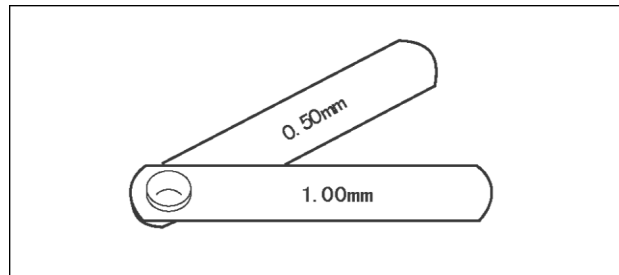

Fig. 1 Copper tube gauge for clearance adjustment

2. Flaring tool (clutch type)

- In the R410A flaring tool, the receiving hole for the clamp bar is enlarged so the clearance from the clamp bar can be set to 0-0.5 mm, and the spring inside the tool is strengthened to increase the strength of the pipe-expanding torque. This flaring tools can also be used with R22 piping, so we recommend that you select it if you are buying a new flaring tool.

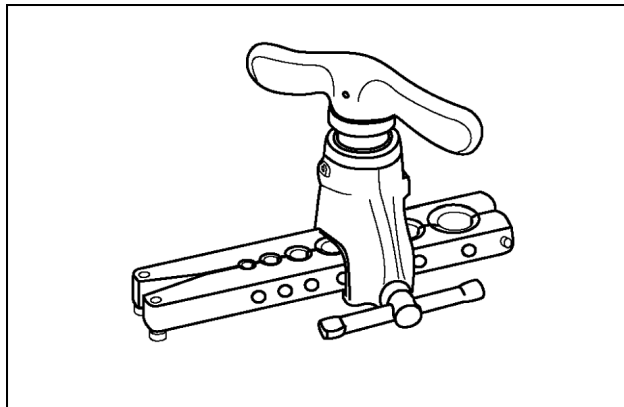

Fig. 2 Flaring tool (clutch type)

3. Torque wrenches

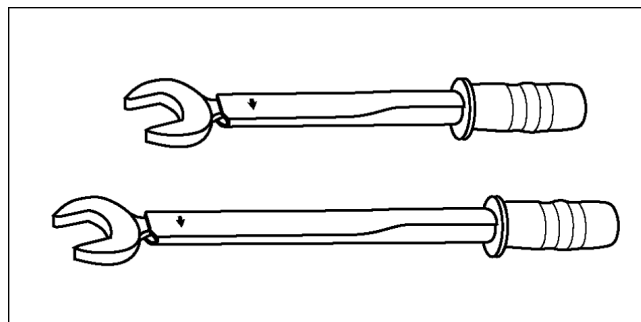

Fig. 3 Torque wrenches

Table 5

	Conventional wrenches	R410A wrenches
For 1/4 (opposite side x torque)	17 mm x 18 N.m (180 kgf.cm)	17 mm x 18 N.m (180 kgf.cm)
For 3/8 (opposite side x torque)	22 mm x 42 N.m (420 kgf.cm)	22 mm x 42 N.m (420 kgf.cm)
For 1/2 (opposite side x torque)	24 mm x 55 N.m (550 kgf.cm)	26 mm x 55 N.m (550 kgf.cm)

4. Manifold gauge

- Because the pressure is higher for the R410A type, the conventional type cannot be used.

Table 6 Difference between R410A and conventional high/low-pressure gauges

	Conventional gauges	R410A gauges
High-pressure gauge (red)	-76 cmHg - 35 kgf/cm ³	-0.1 - 5.3 Mpa -76 cmHg - 53 kgf/cm ³
Low-pressure gauge (blue)	-76 cmHg - 17 kgf/cm ³	-0.1 - 3.8 Mpa -76 cmHg - 38 kgf/cm ³

- The shape of the manifold ports has been changed to prevent the possibility of mistakenly charging with another type of refrigerant.

Table 7 Difference between R410A and conventional manifold port size

	Conventional gauges	R410A gauges
Port size	7/16 UNF 20 threads	1/2 UNF 20 threads

5. Charging hose

- The pressure resistance of the charging hose has been raised to match the higher pressure of R410A. The hose material has also been changed to suit HFC use, and the size of the fitting has been changed to match the manifold ports.

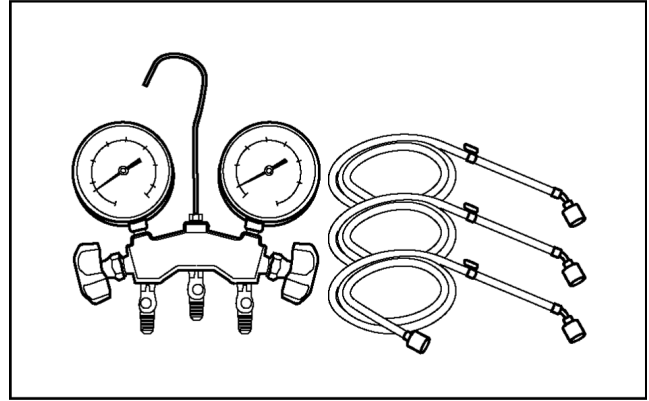

Fig. 4 Manifold gauge charging hose

Table 8 Difference between R410A and conventional charging hoses

		Conventional hoses	R410A hoses
Pressure resistance	Working pressure	3.4 MPa (35 kgf/cm ³)	5.1 MPa (52 kgf/cm ³)
	Bursting pressure	17.2 MPa (175 kgf/cm ³)	27.4 MPa (280 kgf/cm ³)
Material		NBR rubber	HNBR rubber Nylon coating inside

6. Vacuum pump adaptor

- When using a vacuum pump for R410A, it is necessary to install an electromagnetic valve to prevent the vacuum pump oil from flowing back into the charging hose. The vacuum pump adaptor is installed for that purpose. If the vacuum pump oil (mineral oil) becomes mixed with R410A, it will damage the unit.

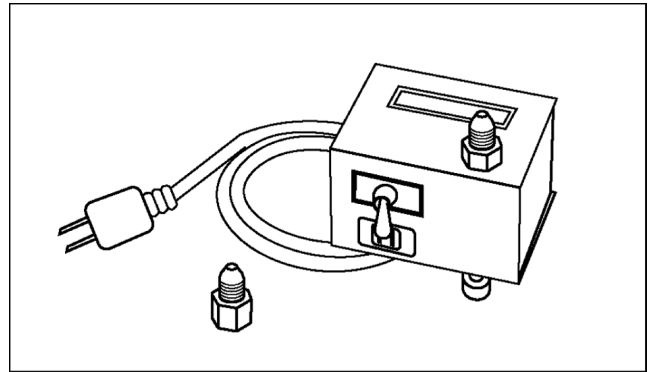

Fig. 5 Vacuum pump adaptor

7. Electric gas leak detector for HFC refrigerant

- The leak detector and halide torch that were used with CFC and HCFC cannot be used with R410A (because there is no chlorine in the refrigerant).
- The present R134a leak detector can be used, but the detection sensitivity will be lower (setting the sensitivity for R134a at 1, the level for R410A will drop to 0.6).
- For detecting small amounts of gas leakage, use the electric gas leak detector for HFC refrigerant. (Detection sensitivity with R410A is about 23 g/year).

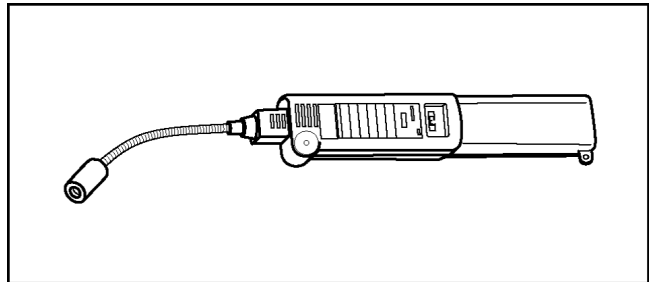

Fig. 6 Electric gas leak detector for HFC refrigerant

8. Electronic scale for refrigerant charging

- Because of the high pressure and fast vaporizing speed of R410A, the refrigerant cannot be held in a liquid phase inside the charging cylinder when charging is done using the charging cylinder method, causing bubbles to form in the measurement scale glass and making it difficult to see the reading. (Naturally, the conventional R22 charging cylinder cannot be used because of the differences in the pressure resistance, scale gradation, connecting port size, etc.)
- The electronic scale has been strengthened by using a structure in which the weight detector for the refrigerant cylinder is held by four supports. It is also equipped with two connection ports, one for R22 (7/16 UNF, 20 threads) and one for R410A (1/2 UNF, 20 threads), so it can also be used for conventional refrigerant charging.
- There are two types of electronic scales, one for 10-kg cylinders and one for 20-kg cylinders. (The 10-kg cylinder is recommended.)

Refrigerant charging is done manually by opening and closing the valve.

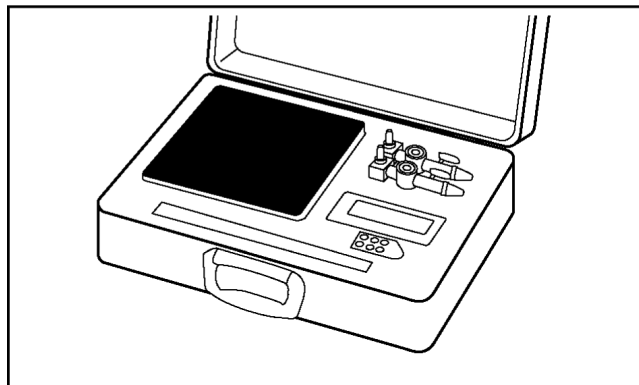

Fig. 7 Electronic scale for refrigerant charging

9. Refrigerant cylinders

- The R410A cylinders are labeled with the refrigerant name, and the coating color of the cylinder protector is pink, which is the color stipulated by ARI of the U.S.
- Cylinders equipped with a siphon tube are available to allow the cylinder to stand upright for liquid refrigerant charging.

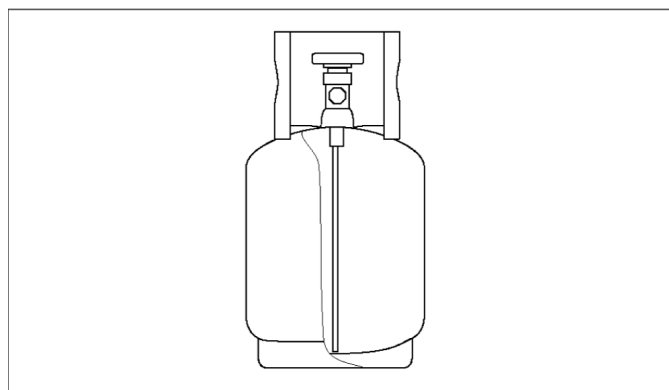

Fig. 8 Refrigerant cylinders

10. Charging orifice and packing for refrigerant cylinders

- The charging orifice must match the size of the charging hose fitting (1/2 UNF, 20 threads).
- The packing must also be made of an HFC-resistant material.

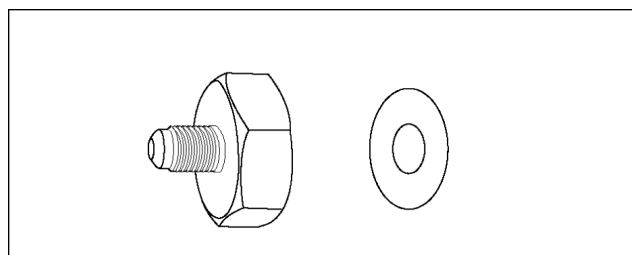

Fig. 9 Charging orifice and packing

11.2.3. R410A tools which are usable for R22 models

Table 9 R410A tools which are usable for R22 models

	R410A tools	Usable for R22 models
(1)	Copper tube gauge for clearance adjustment	OK
(2)	Flaring tool (clutch type)	OK
(3)	Manifold gauge	NG
(4)	Charging hose	NG
(5)	Vacuum pump adaptor	OK
(6)	Electric gas leak detector for HFC refrigerant	NG
(7)	Electronic scale for refrigerant charging	OK
(8)	Refrigerant cylinder	NG
(9)	Charging orifice and packing for refrigerant cylinder	NG

11.3. Refrigerant piping work

11.3.1. Piping materials

It is recommended that you use copper and copper alloy jointless pipes with a maximum oil adherence of 40 mg/10m. Do not use pipes that are crushed, deformed, or discolored (especially the inside surface). If these inferior pipes are used, impurities may clog the expansion valves or capillaries.

Because the pressure of ACs using R410A is higher than those using R22, it is essential that you select materials that are appropriate for these standards.

The thickness of the copper tubing used for R410A is shown in Table 10. Please be aware that tubing with a thickness of only 0.7 mm is also available on the market, but this should never be used.

Table 10 Copper tube thickness (mm)

Soft pipe		Thickness (mm)	
Nominal diameter	Outside diameter (mm)	R410A	(Reference) R22
1/4	6.35	0.80	0.80
3/8	9.52	0.80	0.80
1/2	12.7	0.80	0.80

11.3.2. Processing and connecting piping materials

When working with refrigerant piping, the following points must be carefully observed: no moisture or dust must be allowed to enter the piping, and there must be no refrigerant leaks.

1. Procedure and precautions for flaring work

a. Cut the pipe

Use a pipe cutter, and cut slowly so the pipe will not be deformed.

b. Remove burrs and clean shavings from the cut surface

If the shape of the pipe end is poor after removing burrs, or if shavings adhere to the flared area, it may lead to refrigerant leaks.

To prevent this, turn the cut surface downward and remove burrs, then clean the surface, carefully.

c. Insert the flare nut (be sure to use the same nut that is used on the AC unit)

d. Flaring

Check the clamp bar and the cleanliness of the copper pipe.

Be sure to use the clamp bar to do the flaring with accuracy. Use either an R410A flaring tool, or a conventional flaring tool. Flaring tools come in different sizes, so be sure to check the size before using. When using a conventional flaring tool, use the copper pipe gauge for clearance adjustment, etc., to ensure the correct A dimension (see Fig. 10)

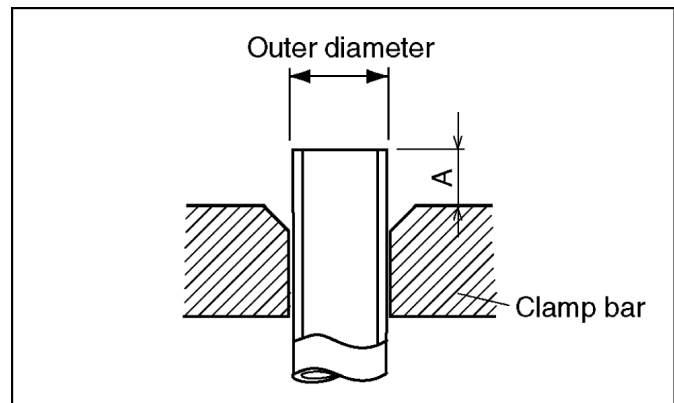

Fig. 10 Flaring dimensions

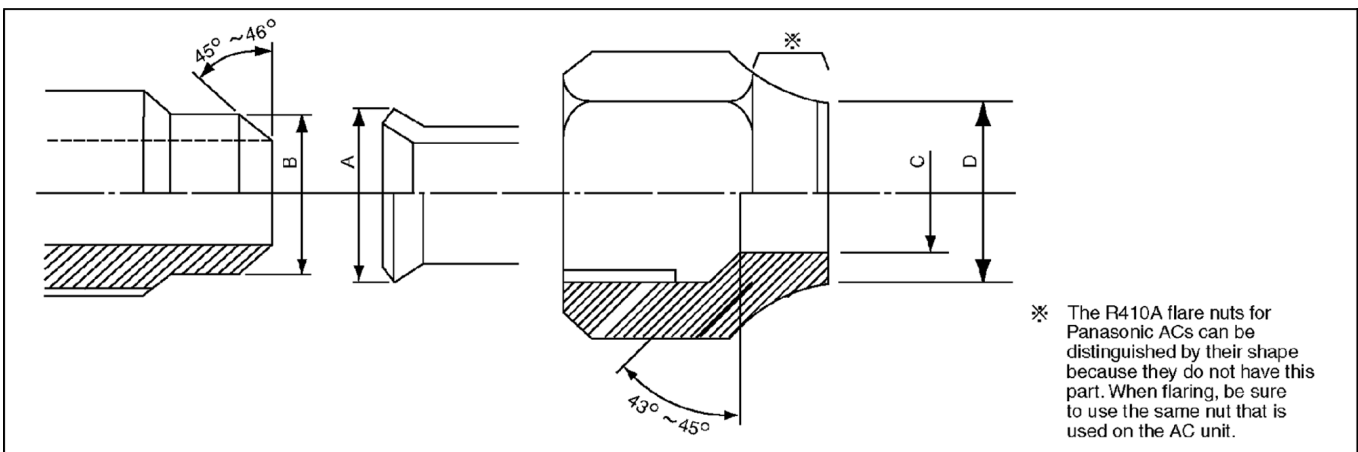

Fig. 11 Relation between the flare nut structure and flaring tool end

Table 11 R410A flaring dimensions

Nominal diameter	Outside diameter (mm)	Wall thickness (mm)	A (mm)		
			R410A flaring tool, clutch type	Conventional flaring tool	
				Clutch type	Wing-nut type
1/4	6.35	0.8	0 - 0.5	1.0 - 1.5	1.5 - 2.0
3/8	9.52	0.8	0 - 0.5	1.0 - 1.5	1.5 - 2.0
1/2	12.70	0.8	0 - 0.5	1.0 - 1.5	2.0 - 2.5

Table 12 R22 flaring dimensions

Nominal diameter	Outside diameter (mm)	Wall thickness (mm)	A (mm)		
			R410A flaring tool, clutch type	Conventional flaring tool	
				Clutch type	Wing-nut type
1/4	6.35	0.8	0 - 0.5	0.5 - 1.0	1.0 - 1.5
3/8	9.52	0.8	0 - 0.5	0.5 - 1.0	1.0 - 1.5
1/2	12.70	0.8	0 - 0.5	0.5 - 1.0	1.5 - 2.0

Table 13 R410A flare and flare nut dimensions Unit: mm

Nominal diameter	Outside diameter (mm)	Wall thickness (mm)	A +0, -0.4	B dimension	C dimension	D dimension	Flare nut width
1/4	6.35	0.8	9.1	9.2	6.5	13	17
3/8	9.52	0.8	13.2	13.5	9.7	20	22
1/2	12.70	0.8	16.6	16.0	12.9	23	26

Table 14 R22 flare and flare nut dimensions Unit: mm

Nominal diameter	Outside diameter (mm)	Wall thickness (mm)	A +0, -0.4	B dimension	C dimension	D dimension	Flare nut width
1/4	6.35	0.8	9.0	9.2	6.5	13	17
3/8	9.52	0.8	13.0	13.5	9.7	20	22
1/2	12.70	0.8	16.2	16.0	12.9	20	24

2. Procedure and precautions for flare connection

- Check to make sure there is no scratches, dust, etc., on the flare and union.
- Align the flared surface with the axial center of the union.
- Use a torque wrench, and tighten to the specified torque. The tightening torque for R410A is the same as the conventional torque value for R22. Be careful, because if the torque is too weak, it may lead to a gas leak. If it is too strong, it may split the flare nut or make it impossible to remove the flare nut.

Table 15 R410A tightening torque

Nominal diameter	Outside diameter (mm)	Tightening torque N.m (kgf.cm)	Torque wrench tightening torque N.m (kgf.cm)
1/4	6.35	14 - 18 (140 - 180)	18 (180)
3/8	9.52	33 - 42 (330 - 420)	42 (420)
1/2	12.70	55 (550)	55 (550)

11.3.3. Storing and managing piping materials

1. Types of piping and their storage

The following is a general classification of the refrigerant pipe materials used for ACs.

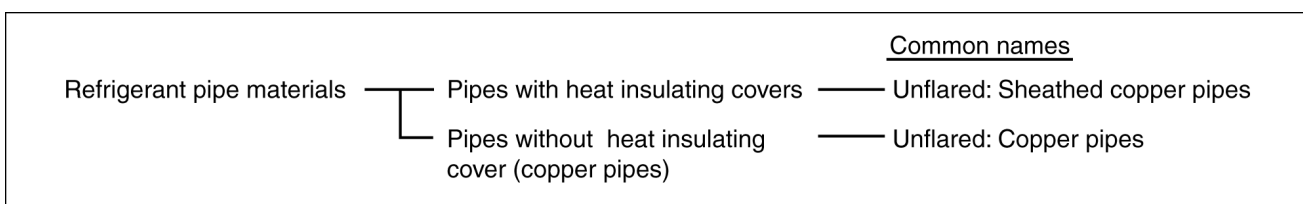

Because the gas pressure of R410A is approximately 1.6 times as high as that of R22, copper pipes with the thickness shown in Table 10, and with minimal impurities must be used. Care must also be taken during storage to ensure that pipes are not crushed, deformed, or scratched, and that no dust, moisture or other substance enters the pipe interior. When storing sheathed copper pipes or plain copper pipes, seal the openings by pinching or taping them securely.

2. Makings and management

a. Sheathed copper pipes and copper-element pipes

When using these pipes, check to make sure that they are the stipulated thickness. For flare nuts, be sure to use the same nut that is used on the AC unit.

b. Copper pipes

Use only copper pipes with the thickness given in table 10, and with minimal impurities. Because the surface of the pipe is exposed, you should take special care, and also take measures such as marking the pipes to make sure they are easily distinguished from other piping materials, to prevent mistaken use.

3. Precautions during refrigerant piping work

Take the following precautions on-site when connecting pipes. (Keep in mind that the need to control the entry of moisture and dust is even more important than in conventional piping).

- a. Keep the open ends of all pipes sealed until connection with AC equipment is complete.
- b. Take special care when doing piping work on rainy days. The entering of moisture will degrade the refrigerating machine oil, and lead to malfunctions in the equipment.
- c. Complete all pipe connections in as short a time as possible. If the pipe must be left standing for a long time after removing the seal, it must be thoroughly purged with nitrogen, or dried with a vacuum pump.

11.4. Installation, transferring, servicing

11.4.1. Inspecting gas leaks with a vacuum pump for new installations (Using new refrigerant piping)

1. From the viewpoint of protecting the global environment, please do not release refrigerant into the atmosphere.
 - a. Connect the projecting side (pin-pushing side) of the charging hose for the manifold gauge to the service port of the 3-way valve. (1)
 - b. Fully open the handle Lo of the manifold gauge and run the vacuum pump. (2) (If the needle of the low-pressure gauge instantly reaches vacuum, re-check step a.)
 - c. Continue the vacuum process for at least 15 minutes, then check to make sure the low-pressure gauge has reached -0.1 MPa (-76 cmHg). Once the vacuum process has finished, fully close the handle Lo of the manifold gauge and stop the vacuum pump operation, then remove the charging hose that is connected to the vacuum pump adaptor. (Leave the unit in that condition for 1-2 minutes, and make sure that the needle of the manifold gauge does not return.) (2) and (3)
 - d. Turn the valve stem of the 2-way valve 90° counter-clockwise to open it, then, after 10 seconds, close it and inspect for a gas leak (4)
 - e. Remove the charging hose from the 3-way valve service port, then open both the 2-way valve and 3-way valve. (1) (4) (Turn the valve stem in the counter-clockwise direction until it gently makes contact. Do not turn it forcefully).
 - f. Tighten the service port cap with a torque wrench (18 N.m (1.8 kgf.m)). (5) Then tighten the 2-way valve and 3-way valve caps with a torque wrench (42 N.m (4.2 kgf.m)) or (55 N.m (5.5 kgf.m)). (6)
 - g. After attaching each of the caps, inspect for a gas leak around the cap area. (5) (6)

Precautions

- Be sure to read the instructions for the vacuum pump, vacuum pump adaptor and manifold gauge prior to use, and follow the instructions carefully.
- Make sure that the vacuum pump is filled with oil up to the designated line on the oil gauge.
- The gas pressure back flow prevention valve on the charging hose is generally open during use. When you are removing the charging hose from the service port, it will come off more easily if you close this valve.

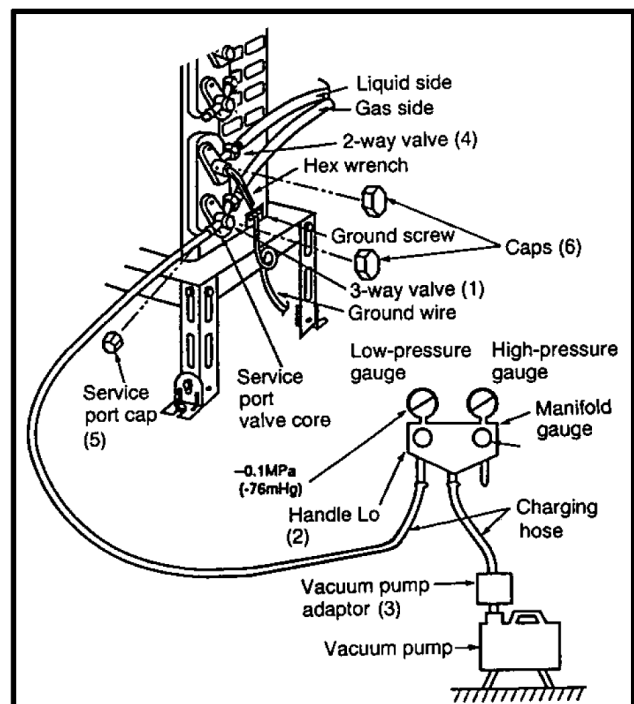

Fig. 12 Vacuum pump air purging configuration

11.4.2. Transferring (Using new refrigerant piping)

1. Removing the unit

a. Collecting the refrigerant into the outdoor unit by pumping down

The refrigerant can be collected into the outdoor unit (pumping down) by pressing the TEST RUN button, even when the temperature of the room is low.

- Check to make sure that the valve stems of the 2-way valve and 3-way valve have been opened by turning them counter-clockwise. (Remove the valve stem caps and check to see that the valve stems are fully opened position. Always use a hex wrench (with 4-mm opposing sides) to operate the valve stems.)
- Press the TEST RUN button on the indoor unit, and allow preliminary operation for 5-6 minutes. (TEST RUN mode)
- After stopping the operation, let the unit sit for about 3 minutes, then close the 2-way valve by turning the valve stem in the clockwise direction.
- Press the TEST RUN button on the indoor unit again, and after 2-3 minutes of operation, turn the valve stem of the 3-way valve quickly in the clockwise direction to close it, then stop the operation.
- Tighten the caps of the 2-way valve and 3-way valve to the stipulated torque.
- Remove the connection pipes (liquid side and gas side).

b. Removing the indoor and outdoor units

- Disconnect the pipes and connecting electric cables from between the indoor and outdoor units.
- Put capped flare nuts onto all of the pipe connections of the indoor and outdoor units, to make sure no dust or other foreign matter enters.
- Remove the indoor and outdoor units.

2. Installing the unit

Install the unit using new refrigerant piping. Follow the instructions in section 4.1 to evacuate the pipes connecting the indoor and outdoor units, and the pipes of the indoor unit, and check for gas leaks.

11.4.3. AC units replacement (Using existing refrigerant piping)

When replacing an R410A AC unit with another R410A AC unit, you should re-flare the refrigerant piping. Even though the replacement AC unit uses the R410A, problems occur when, for example, either the AC unit maker or the refrigerating machine oil is different.

When replacing an R22 AC unit with an R410A AC unit, the following checks and cleaning procedures are necessary but are difficult to do because of the chemical characteristics of the refrigerating machine oil (as described in items c) and d) of section **About R410A Refrigerant**). In this case, you should use new refrigerant piping rather than the existing piping.

1. Piping check

Because of the different pressure characteristics of R22 and R410A, the design pressure for the equipment is 1.6 times different. The wall thickness of the piping must comply with that shown in Table 10, but this is not easy to check. Also, even if the thickness is correct, there may be flattened or bent portions midway through the piping due to sharp curves. Buried sections of the piping also cannot be checked.

2. Pipe cleaning

A large quantity of refrigerating machine oil (mineral oil) adheres to existing pipes due to the refrigeration cycle circulation. If the pipes are used just as they are for the R410A cycle, the capacity will be lowered due to the incompatibility of this oil with the R410A, or irregularities may occur in the refrigeration cycle. For this reason, the piping must be thoroughly cleaned, but this is difficult with the present technology.

11.4.4. Refrigerant compatibility (Using R410A refrigerant in R22 ACs and vice versa)

Do not operate an existing R22 AC with the new R410A refrigerant. Doing so would result in improper functioning of the equipment or malfunction, and might lead to a major accident such as an explosion in the refrigeration cycle. Similarly, do not operate an R410A AC with R22 refrigerant. The chemical reaction between the refrigerating machine oil used in R410A ACs and the chlorine that is contained in R22 would cause the refrigerating machine oil to degrade and lead to malfunction.

11.4.5. Recharging refrigerant during servicing

When recharging is necessary, insert the specified amount of new refrigerant in accordance with the following procedure.

1. Connect the charging hose to the service port of the outdoor unit.
2. Connect the charging hose to the vacuum pump adaptor. At this time, fully open the 2-way valve and 3-way valve.

3. Fully open the handle Lo of the manifold gauge, turn on the power of the vacuum pump and continue the vacuum process for at least one hour.
4. Confirm that the low pressure gauge shows a reading of -0.1 Mpa (-76 cmHg), then fully close the handle Lo, and turn off the vacuum pump. Wait for 1-2 minutes, then check to make sure that the needle of the Low pressure gauge has not returned. See Fig. 13 for the remaining steps of this procedure.
5. Set the refrigerant cylinder onto the electronic scale, then connect the hose the cylinder and to the connection port for the electronic scale. (1)(2)

Precaution:

Be sure to set up the cylinder for liquid charging. If you use a cylinder equipped with a siphon tube, you can charge the liquid without having to turn the cylinder around

6. Remove the charging hose of the manifold gauge from the vacuum pump adaptor, and connect it to the connection port of the electronic scale. (2)(3)
7. Open the valve of the refrigerant cylinder, then open the charging valve slightly and close it. Next, press the check valve of the manifold gauge and purge the air. (2)(4) (Watch the liquid refrigerant closely at this point.)
8. After adjusting the electronic scale to zero, open the charging valve, then open the valve Lo of the manifold gauge and charge with the liquid refrigerant. (2)(5) (Be sure to read the operating instructions for the electronic scale.)
9. If you cannot charge the stipulated amount, operate the unit in the cooling mode while charging a little of the liquid at a time (about 150 g/time as a guideline). If the charging amount is insufficient from one operation, wait about one minute, then use the same procedure to do the liquid charging again.

Precaution:

Never use the gas side to allow a larger amount of liquid refrigerant to be charged while operating the unit.

10. Close the charging valve, and after charging the liquid refrigerant inside the charging hose, fully close the valve Lo of the manifold gauge, and stop the operation of the unit. (2)(5)
11. Quickly remove the charging hose from the service port. (6) If you stop midway through, the refrigerant that is in the cycle will be discharged.
12. After putting on the caps for the service port and operating valve, inspect around the caps for a gas leak. (6)(7)

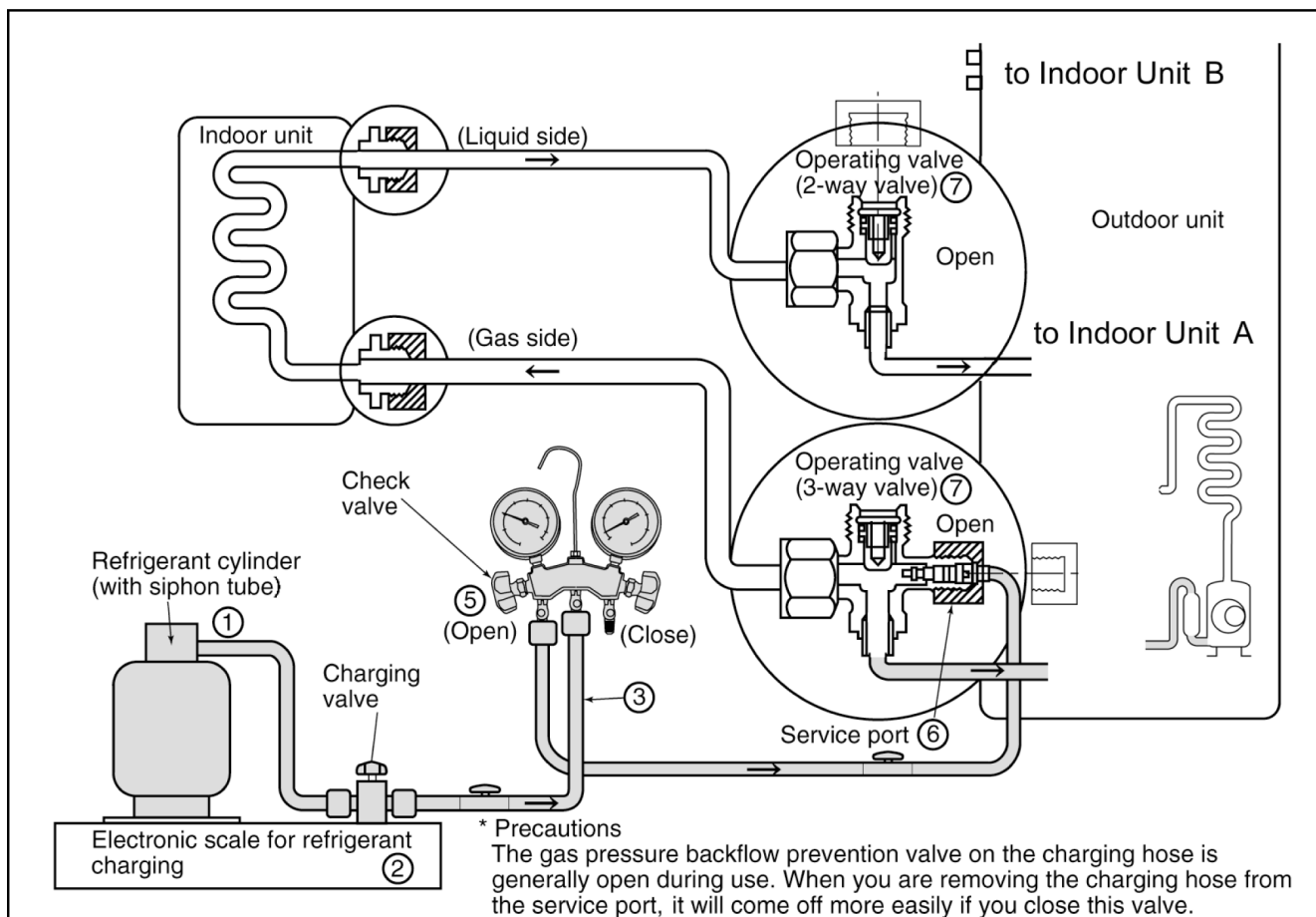

Fig. 13 Re-charging refrigerant

11.4.6. Brazing

As brazing requires sophisticated techniques and experiences, it must be performed by a qualified person. In order to prevent the oxide film from occurring in the pipe interior during brazing, it is effective to proceed with brazing while letting dry nitrogen gas (N₂) flow.

<Brazing Method for Preventing Oxidation>

1. Attach a reducing valve to the nitrogen gas cylinder.
2. Apply a seal onto the clearance between the piping and inserted pipe for the nitrogen gas in order to prevent the nitrogen gas from flowing backward.
3. When the nitrogen gas is flowing, be sure to keep the piping end open.
4. Adjust the flow rate of nitrogen gas so that it is lower than 0.05 m³/h, or 0.02 MPa (0.2 kgf/cm²) by means of the reducing valve.
5. After taking the steps above, keep the nitrogen gas flowing until the piping cools down to a certain extent (i.e. temperature at which pipes are touchable with finger).
6. Completely remove the flux after brazing.

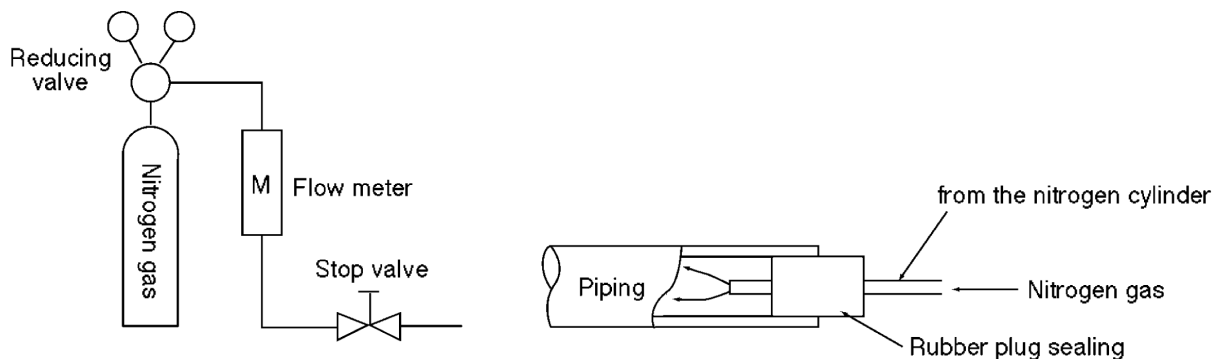

Fig. 14 Prevention of Oxidation during Brazing

Cautions during brazing

1. General Cautions

- a. The brazing strength should be high as required.
- b. After operation, airtightness should be kept under pressurized condition.
- c. During brazing do not allow component materials to become damaged due to overheating.
- d. The refrigerant pipe work should not become blocked with scale or flux.
- e. The brazed part should not restrict the flow in the refrigerant circuit.
- f. No corrosion should occur from the brazed part.

2. Prevention of Overheating

Due to heating, the interior and exterior surfaces of treated metal may oxidize. Especially, when the interior of the refrigerant circuit oxidizes due to overheating, scale occurs and stays in the circuit as dust, thus exerting a fatally adverse effect. So, make brazing at adequate brazing temperature and with minimum of heating area.

3. Overheating Protection

In order to prevent components near the brazed part from overheating damage or quality deterioration due to flame or heat, take adequate steps for protection such as (1) by shielding with a metal plate, (2) by using a wet cloth, and (3) by means of heat absorbent.

4. Movement during Brazing

Eliminate all vibration during brazing to protect brazed joints from cracking and breakage.

5. Oxidation Preventative

In order to improve the brazing efficiency, various types of antioxidant are available on the market. However, the constituents of these are widely varied, and some are anticipated to corrode the piping materials, or adversely affect HFC refrigerant, lubricating oil, etc. Exercise care when using an oxidation preventative.

11.4.7. Servicing tips

The drier must also be replaced whenever replacing the refrigerant cycle parts. Replacing the refrigerant cycle parts first before replacing the drier. The drier is supplied in a vacuum pack. Perform brazing immediately after opening the vacuum pack, and then start the vacuum within two hours. In addition, the drier also needs to be replaced when the refrigerant has leaked completely. (Applicable for drier models only)

12 TROUBLE SHOOTING GUIDE

12.1. Self-diagnosis

- The display screen on the wired remote control unit and the self-diagnosis LEDs (green) on the outdoor unit printed circuit board in the outdoor unit can be used to indicate where the location of a problem is.

Refer to the table below to remove the cause of the problem, and then re-start the air conditioner system.

- If the problem disappears and operation returns to normal, the CHECK display on the remote control unit will switch off, but the self-diagnosis LED will remain illuminated until operation is resumed. ●... illuminated ○... flashing Blank off.

Wired remote control unit display		Outdoor unit printed circuit board LED								Location or problem	Check location
Abnormal display	Detail display	302	303	304	305	306	307	308	309		
F15	-01		○	○	○	○		(※2)	(※2)	Drain level Float switch problem	Drain pump and drain pipe, indoor unit connectors CN-DRMTR&CN-TH2
F16	-01						○	(※2)	(※2)	Louver switch problem	Louver motor, decorative panel connection terminal, or indoor unit louver motor connectors
F17	-02	○	○				○	(※2)	(※2)	D. C Fan Motor problem	Indoor unit D. C Fan motor or connection terminals
F20	-01				○		○	(※2)	(※2)	Indoor temperature sensor problem	Indoor temperature sensor lead wire or indoor unit connector or CN-TH2
	-02	○			○		○	(※2)	(※2)	Remote control thermistor problem	Remote control thermistor
F21	-01		○		○		○	(※2)	(※2)	Pipe temp. sensor problem (indoor unit)	Pipe temperature sensor lead wire or indoor unit connector CN-TH1
F26	-01			○		○	○	(※2)	(※2)	Remote control transmission problem	Remote control unit cable and connection terminals
F27	-01		○	○		○	○	(※2)	(※2)	Indoor/outdoor unit disconnection problem	Indoor/outdoor unit connection cable and connection terminals, or indoor unit and outdoor unit power supplies (indoor side)
	-05	○	○	○		○	○	(※2)	(※2)	Indoor/outdoor unit connection problem	Indoor/outdoor unit connection wire (indoor side)
F27	-01	○		○		○				Indoor/outdoor unit disconnection problem	Indoor/outdoor unit connection cable and connection terminals, or indoor unit and outdoor unit power supplies (outdoor side)
	-05					○				Indoor/outdoor unit connection error problem	Indoor/outdoor unit connection wire (outdoor side)
F30	-01						○			System problem	Total capacity for the number of indoor units is insufficient, or over check the total capacity and the number of indoor units
	-02			○			○			Open phase, or reversed phase of supply	Check the main power supply terminal board connections, or switch over any two of the power supply wires.
F31	-01		○							Suction pressure protection	Insufficient refrigerant
	-02	○								High-pressure cut-off	Check the Refrigeration system
	-06			○	○					4 way valve problem	Check the 4 way valve or lead wire
	-08		○				○			Freezing problem (Cooling model)	Check the Refrigerant system
	-09		○	○	○					Leakage Refrigerant problem	Check the Refrigerant system
	-10		○	○		○				Refrigerant system problem	Insufficient refrigerant or valve operation (closed)
F32	-03			○		○				Inverter protection (Low DC voltage)	Check the Power supply
	-04	○	○			○				Inverter protection (IPM protection)	IPM fault or PCB (MAIN) fault
	-05	○	○							Compressor overcurrent protection	Open phase or lock in compressor
	-06	○	○		○					Compressor discharge temp. protection	Insufficient refrigerant
	-08	○		○	○					Inverter protection (PFC protection)	PFC fault (PCB-PFC fault)
	-09	○				○				Inverter protection (DC current protection)	IPM fault or lock in compressor
	-10	○	○	○	○					Number of rotation Compressor problem	IPM fault or lock in compressor
F35	-02		○			○				D. C Fan motor lock problem	D. C Fan motor lock

Wired remote control unit display		Outdoor unit printed circuit board LED								Location or problem	Check location
Abnormal display	Detail display	302	303	304	305	306	307	308	309		
F40	-01			○						Outlet temperature sensor problem	Outlet temperature sensor lead wire, connector CN-TH1
	-11				○					Compressor suction temperature sensor problem	Suction temperature sensor (SUC T. TEMP) lead wire, connector CN-TH2 or valve operation (closed)
	-21	○		○						Heat exchanger outlet temperature sensor problem	Heat exchanger outlet temperature sensor (COND TEMP) lead wire, connector CN-TH1
	-31	○	○	○						Pipe temperature sensor problem	Pipe temperature sensor (PIPE TEMP) lead wire, connector CN-TH2
	-51		○	○						Compressor discharge temperature sensor problem	Compressor discharge temperature sensor (DIS T. TEMP) lead wire, connector CN-DIS
F41	-02	○	○					○		High pressure switch open circuit problem	High-pressure switch lead wire, connector CN-PSW1
	-11	○						○		Low pressure sensor problem	Low-pressure sensor lead wire, connector
F42	-11		○		○					Current detector open circuit	Outdoor unit P.C. B (NOISE FILTER) fault or connector ACN2
F44	-01	○			○					Inverter protection (IPM temp. sensor problem)	IPM fault or PCB (MAIN) fault

(※2)	LED308	LED309	Unit No. (when twin or triple)
	●		Master unit problem
		●	Slave No. 1 unit problem
	●	●	Slave No. 2 unit problem

- The LED301 (green) illuminates to indicate that the microprocessor on the printed circuit board is operating normally.
If the LED is switched off or flashing irregularly. Check the power supply, and turn it off and then back on again

13 REPLACEMENT PARTS

13.1. INDOOR UNIT

CS-F50DD2E5

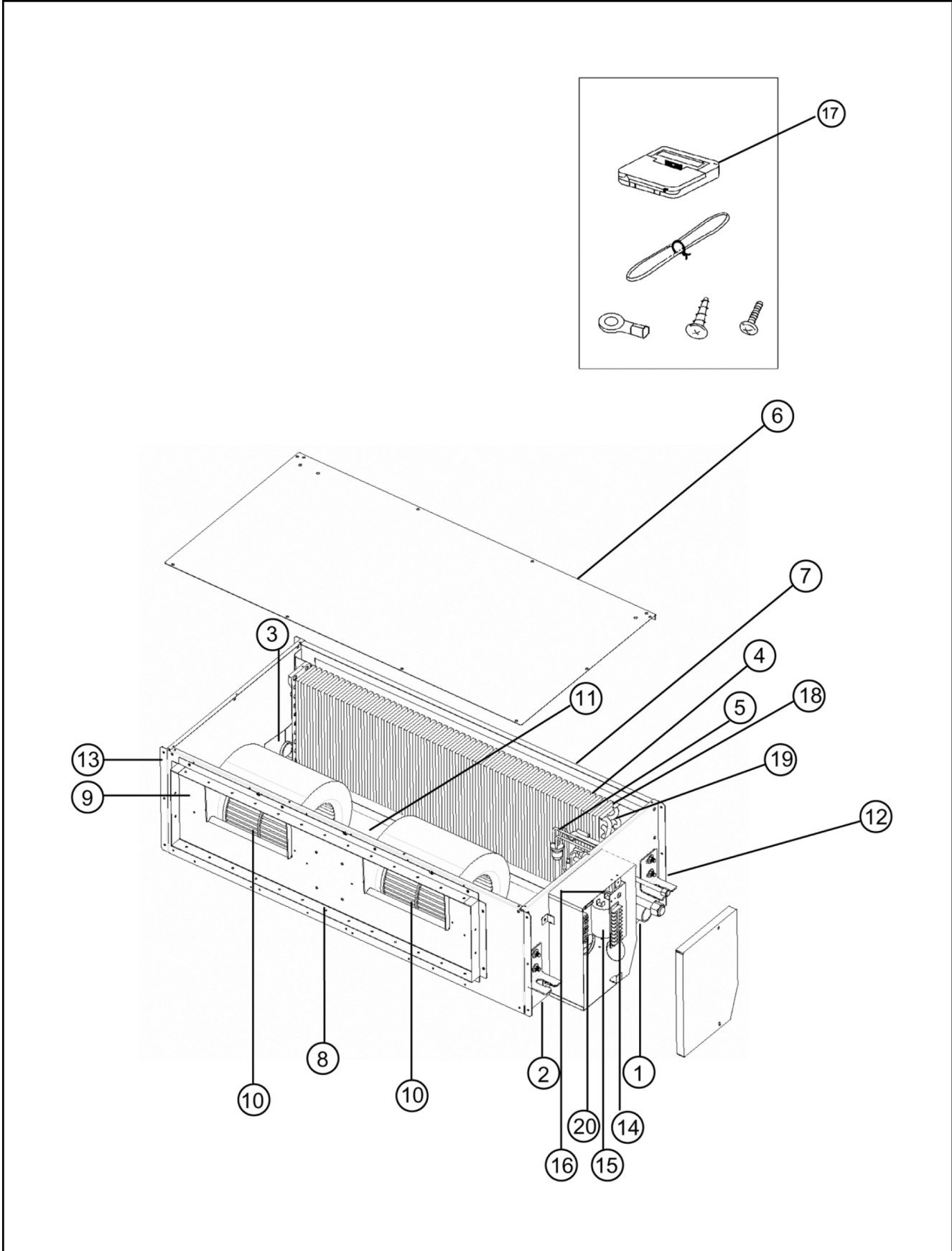

CS-F50DD2E5

REF. NO.	PARTS NAME	Q'TY	QUANTITY PER 1 UNIT
			CS-F50DD2E5
1	Cabinet (Bottom)	1	P02-T08130
2	Cabinet (Bottom A)	1	P02-T08140
3	Drain pan	1	P42-T03920
4	Evaporator	1	P45-T07890
5	Distributor as.	1	P45-T07770
6	Cabinet (Top)	1	P02-T07490
7	Cabinet (Back)	1	P42-T03400
8	Duct flange as.(Outlet)	1	P42-T02150
9	Fan base as.	1	P45-T07720
10	Casing as.	2	P45-T07990
11	Fan motor	1	P06-T04920
12	Panel side R as.	1	P42-T03880
13	Panel side L as.	1	P42-T03890
14	Terminal board	1	P06-T04970
15	Capacitor	1	P06-T04350
16	Transformer	1	A40C1031
17	Remote control	1	A75C2742
18	Thermistor as.	1	P46-T06800
19	Coil sensor	1	P46-T06790
20	PCB assembly (No program)	1	A743681
	PCB assembly (Programed)	1	P46-T07030

All parts are supplied from Taiwan (Tamaco).

13.2. OUTDOOR UNIT

CU-L50DBE8

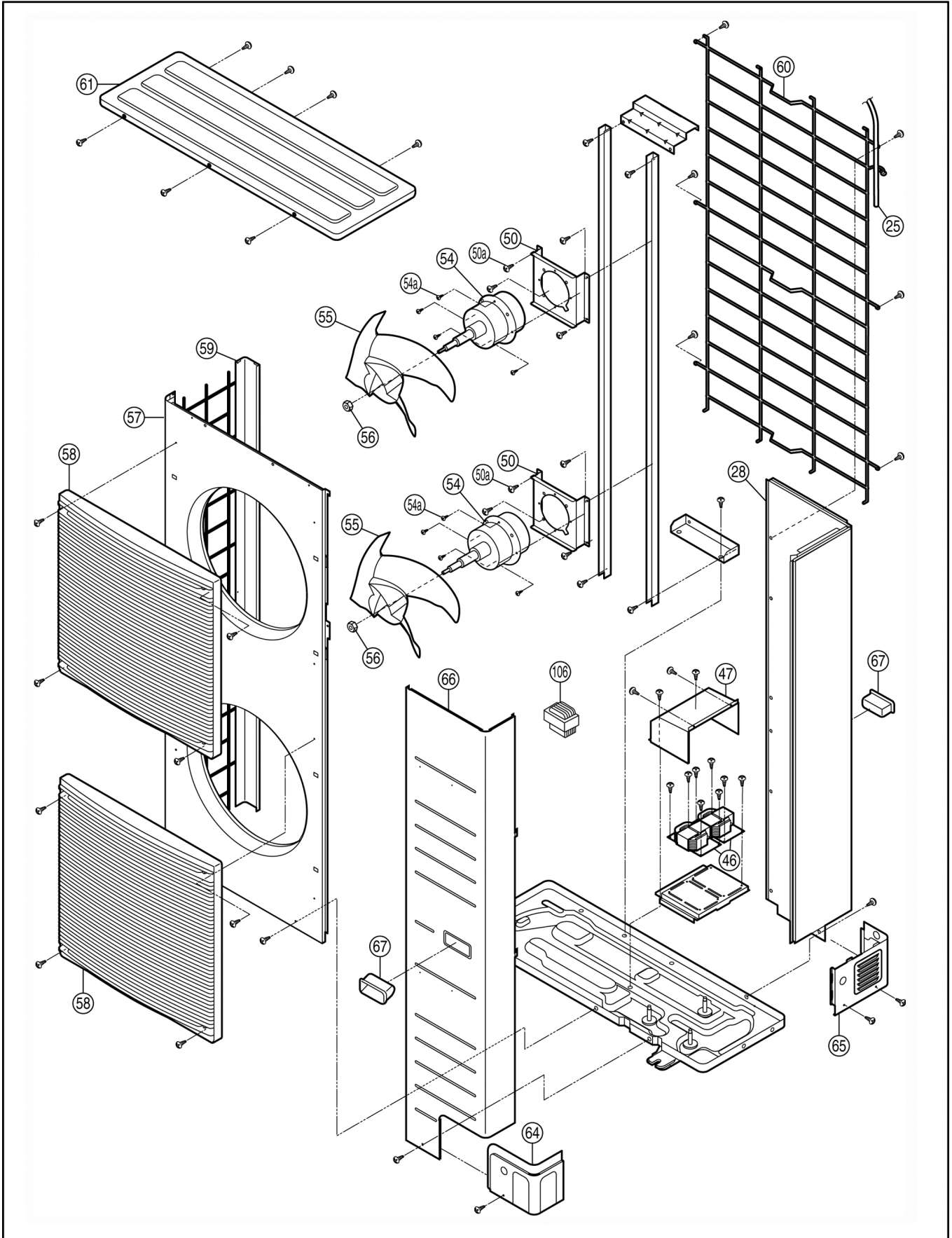

CU-L50DBE8

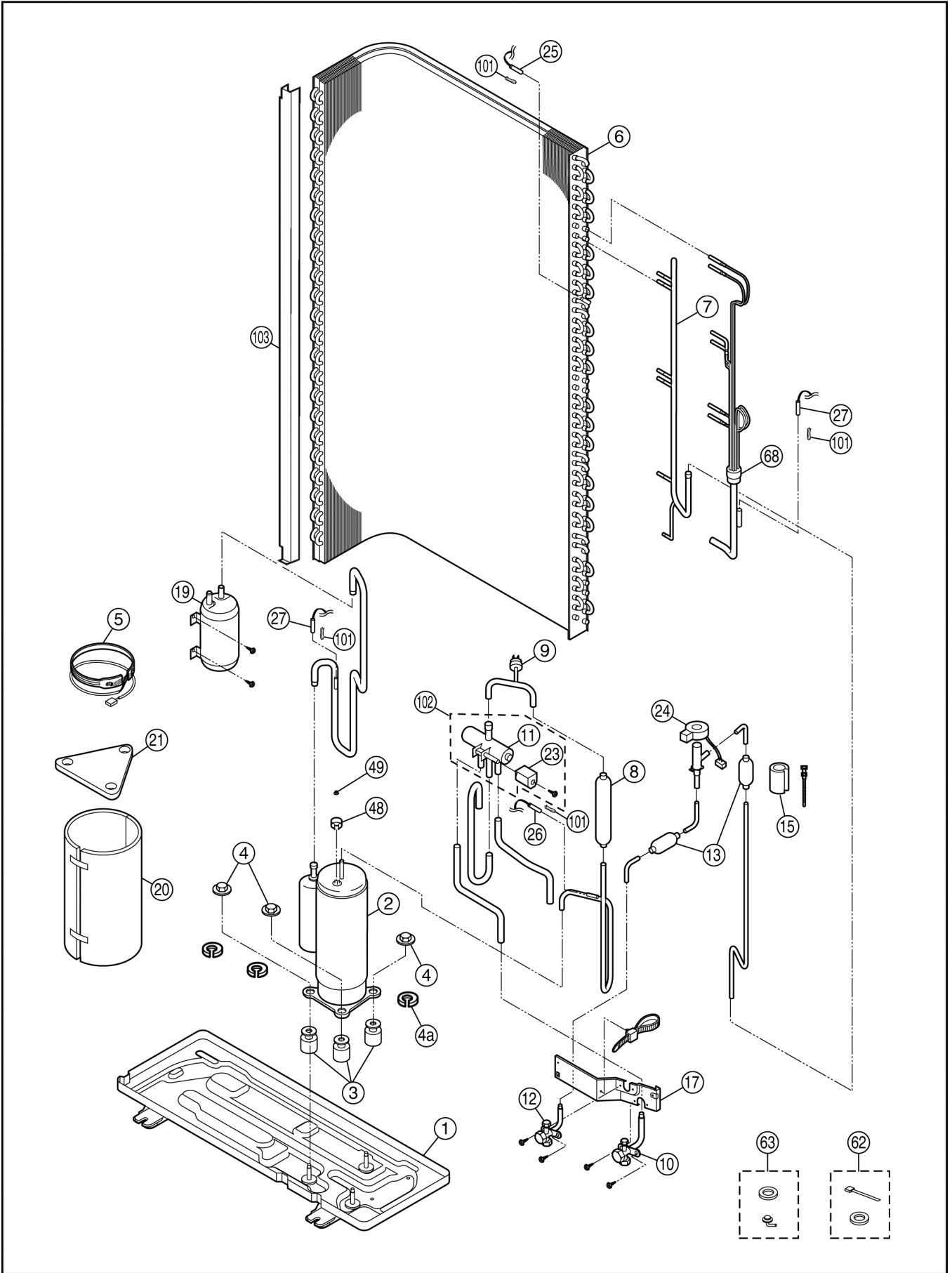

CU-L50DBE8

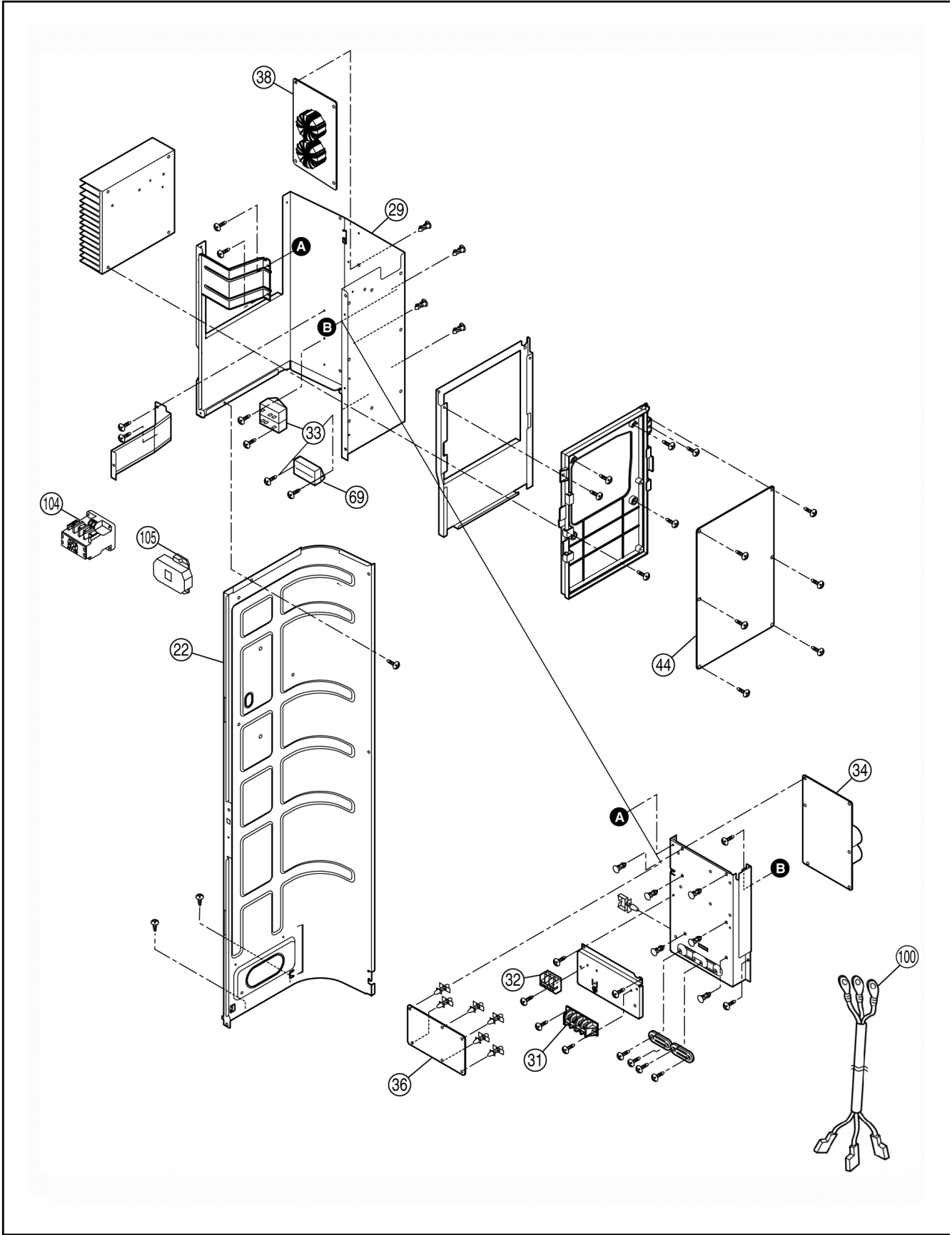

NO.	PART DESCRIPTION	QTY.	CU-L50DBE8
1	BASE PAN ASS'Y	1	CWD52K1110
2	COMPRESSOR	1	5JD420XBA22
3	ANTI-VIBRATION BUSHING	3	CWH50055
4	NUT FOR COMP. MOUNT.	3	CWH4582065
4a	PACKING	3	CWB811017
5	CRANKCASE HEATER	1	CWA341013
6	CONDENSER COMPLETE	1	CWB32C1594
7	TUBE ASS'Y(PRESSURE SWITCH)	1	CWT023392
8	DISCHARGE MUFFLER	1	CWB121014
9	HIGH PRESSURE SWITCH	1	CWA101007
10	3-WAYS VALVE (GAS)	1	CWB011251
11	4-WAYS VALVE	1	CWB001046
12	3-WAYS VALVE (LIQUID)	1	CWB011292
13	STRAINER	2	CWB111032
15	PIPE HOLDER RUBBER	5	CWG251021
17	HOLDER-SERVICE VALVE	1	CWD911425
19	ACCUMULATOR ASS'Y	1	CWB131026A
20	SOUND PROOF MATERIAL-COMP	1	CWG302265
21	SOUND PROOF MATERIAL	1	CWG302266
22	SOUND-PROOF BOARD ASS'Y	1	CWH15K1019
23	V-COIL COMPLETE	1	CWA43C2169
24	V-COIL COMPLETE	1	CWA43C2177
25	PIPE SENSOR (DISCHARGE)	1	CWA50C2229
26	PIPE SENSOR (COIL)	1	CWA50C2230
27	PIPING SENSOR	1	CWA50C2231
28	CABINET REAR PLATE	1	CWE02C1014
29	CONTROL BOARD ASS'Y	1	CWH10K1049
31	TERMINAL BOARD ASS'Y	1	CWA28K1111
32	TERMINAL BOARD ASS'Y	1	CWA28K1076
33	CAPACITOR-FAN MOTOR (3/460)	2	DS461305QP-A
34	ELECTRONIC CONTROLLER (P. SUPPLY)	1	CWA743633
36	ELECTRONIC CONTROLLER (DISPLAY)	1	CWA743403
38	ELECTRONIC CONTROLLER (NOISE FILTER)	1	CWA743814
44	ELECTRONIC CONTROLLER (MAIN)	1	CWA73C1798R
46	REACTOR	2	-
47	PARTICULAR PLATE COVER ASS'Y	1	-
48	TERMINAL COVER	1	CWH171035
49	NUT FOR TERMINAL COVER	1	CWH7080300
50	BRACKET FAN MOTOR	1	CWD54K1014
50a	SCREW-BRACKET FAN MOTOR	4	CWH551040
54	FAN MOTOR	2	CWA951363
54a	SCREW-FAN MOTOR	8	CWH551040
55	PROPELLER FAN	2	CWH001021
56	NUT for PROPELLER FAN	2	CWH561038
57	CABINET FRONT PLATE	1	CWE061098A
58	DISCHARGE GRILLE	2	CWE201073
59	CABINET SIDE PLATE	1	CWE04K1023A
60	WIRE NET	1	CWD041068A
61	CABINET TOP PLATE COMPLETE	1	CWE03C1021
62	ACCESSORY COMPLETE	1	CWH82C1105
63	BAG-COMPLETE (L-TUBE)	1	CWG87C2030
64	PIPE COVER (FRONT)	1	CWD601074A
65	PIPE COVER (BACK)	1	CWD601075A
66	CABINET FRONT PLATE COMPLETE	1	CWE06C1091
67	HANDLE	2	CWE161008
68	TUBE ASS'Y (CAPILLARY TUBE)	1	CWT07K1196
69	MAGNETIC SWITCH	1	K6C2AGA00002
100	LEADWIRE-COMPRESSOR	1	-
101	SPRING FOR SENSOR	4	CWH711010
102	4-WAYS VALVE COMPLETE	1	CWB00C1022
103	CONDENSER SIDE PLATE	1	CWD932477
104	ELECTRO MAGNETIC SWITCH	1	CWA001005
105	PTC THERMISTORS	1	D4DDG1010001
106	NORMAL - MODE LINE CHOKE COILS	1	G0A452N00002
	INSTALLATION INSTRUCTION	1	CWF612612

All parts are supplied from PHAAM, Malaysia (Vendor Code: 061)

14 ELECTRONIC CIRCUIT DIAGRAM

14.1. Indoor unit

SCHEMATIC DIAGRAM 1/4

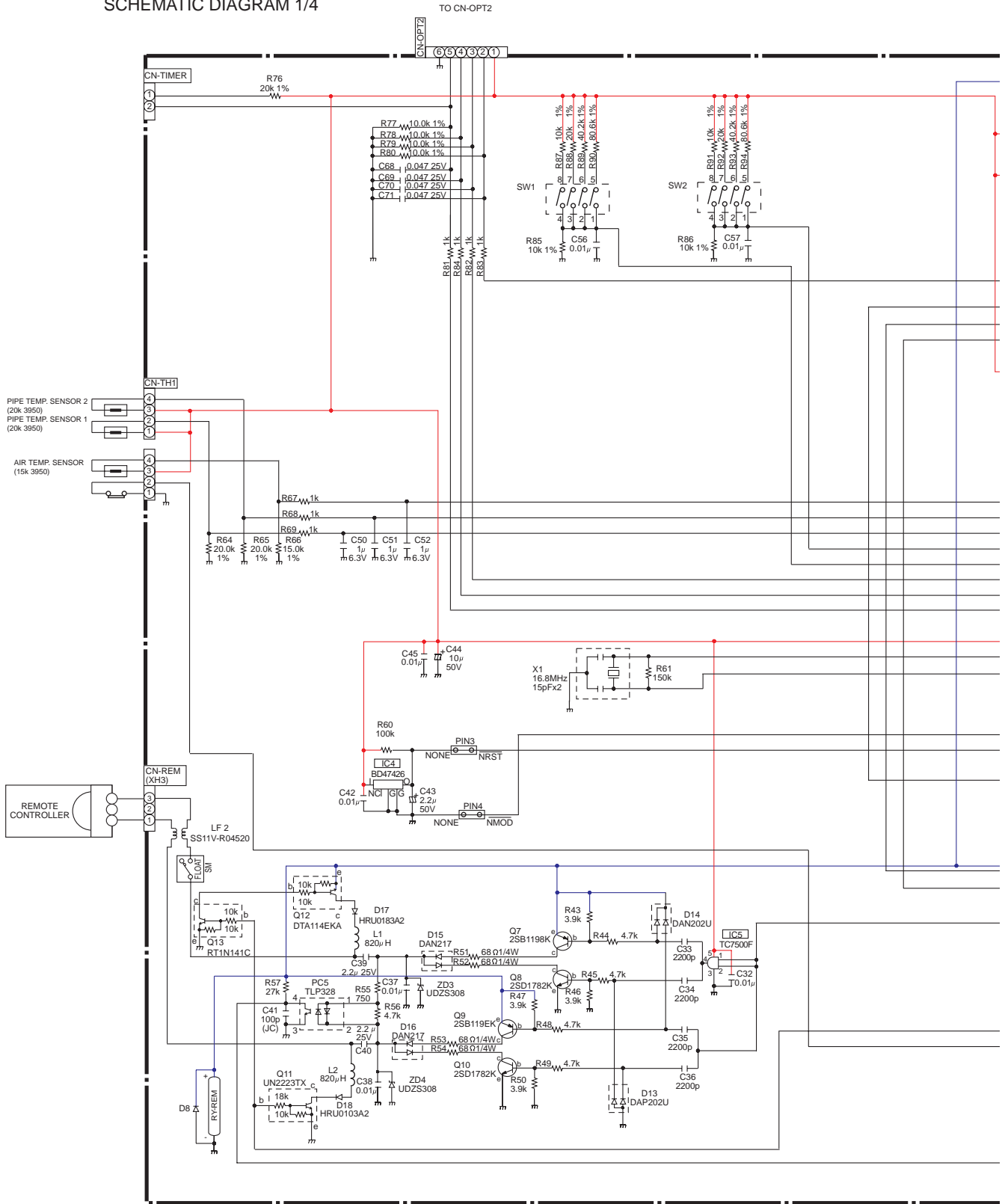

SCHEMATIC DIAGRAM 2/4

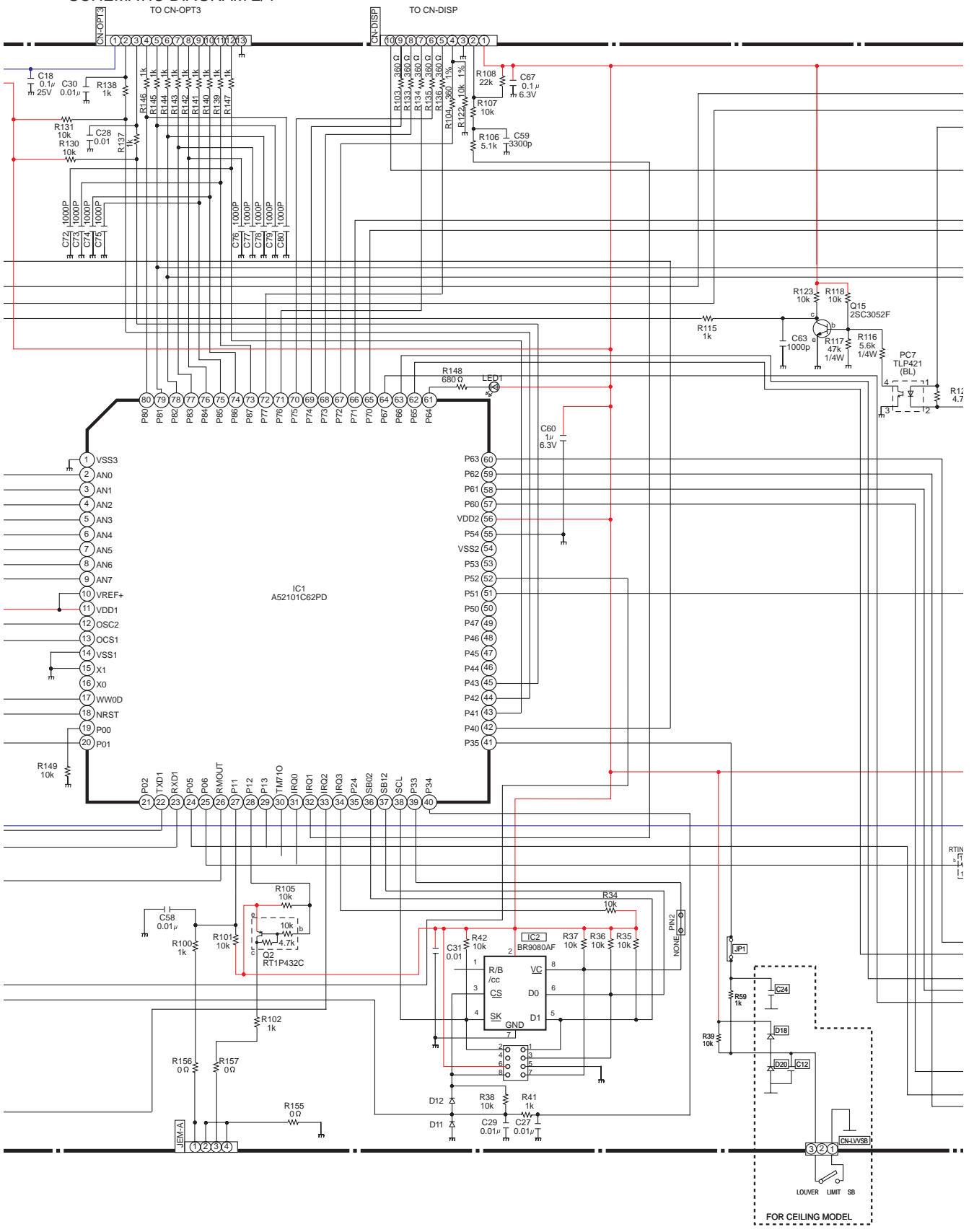

SCHEMATIC DIAGRAM 3/4

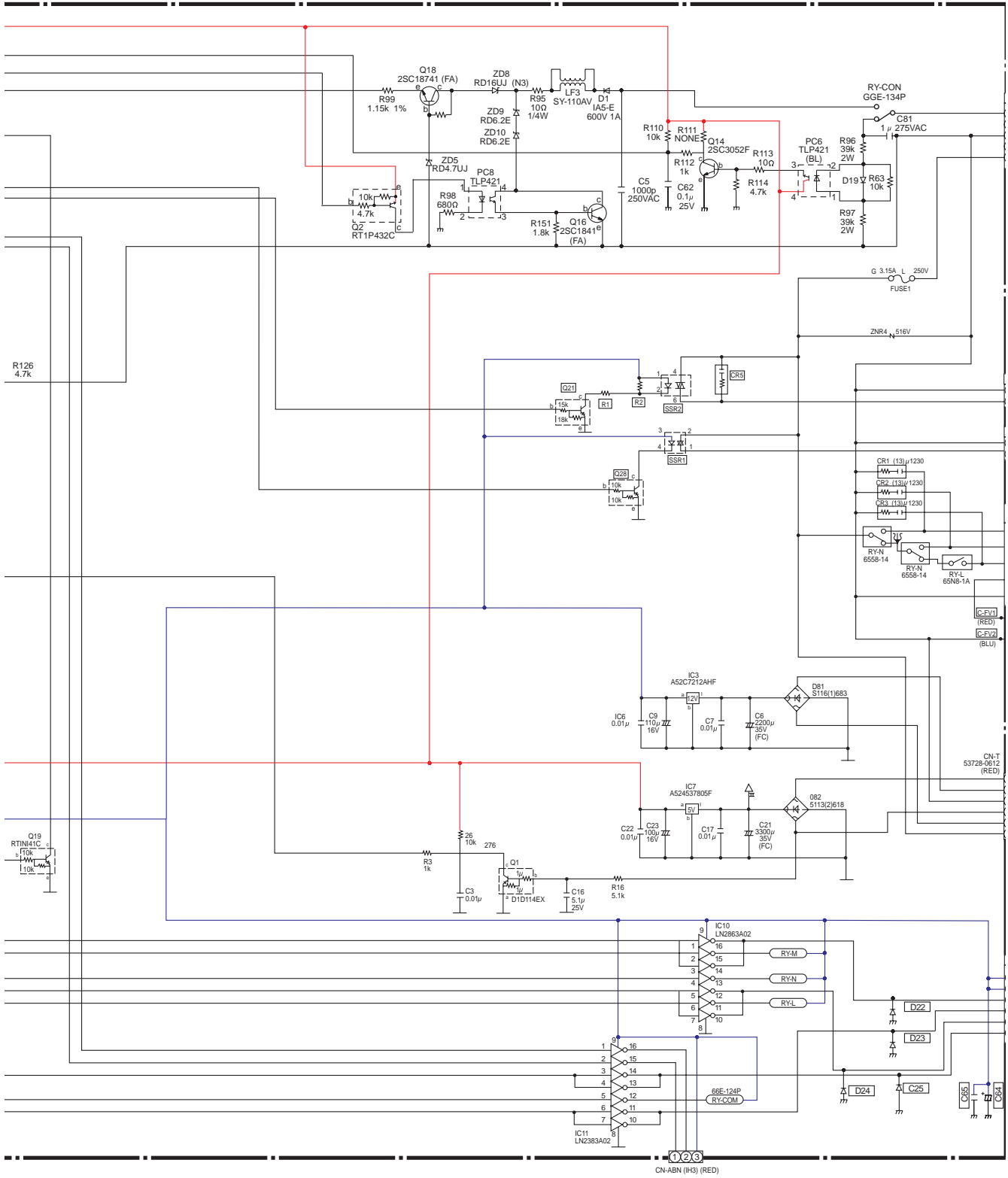

SCHEMATIC DIAGRAM 4/4

ELECTRONIC CONTROL UNIT

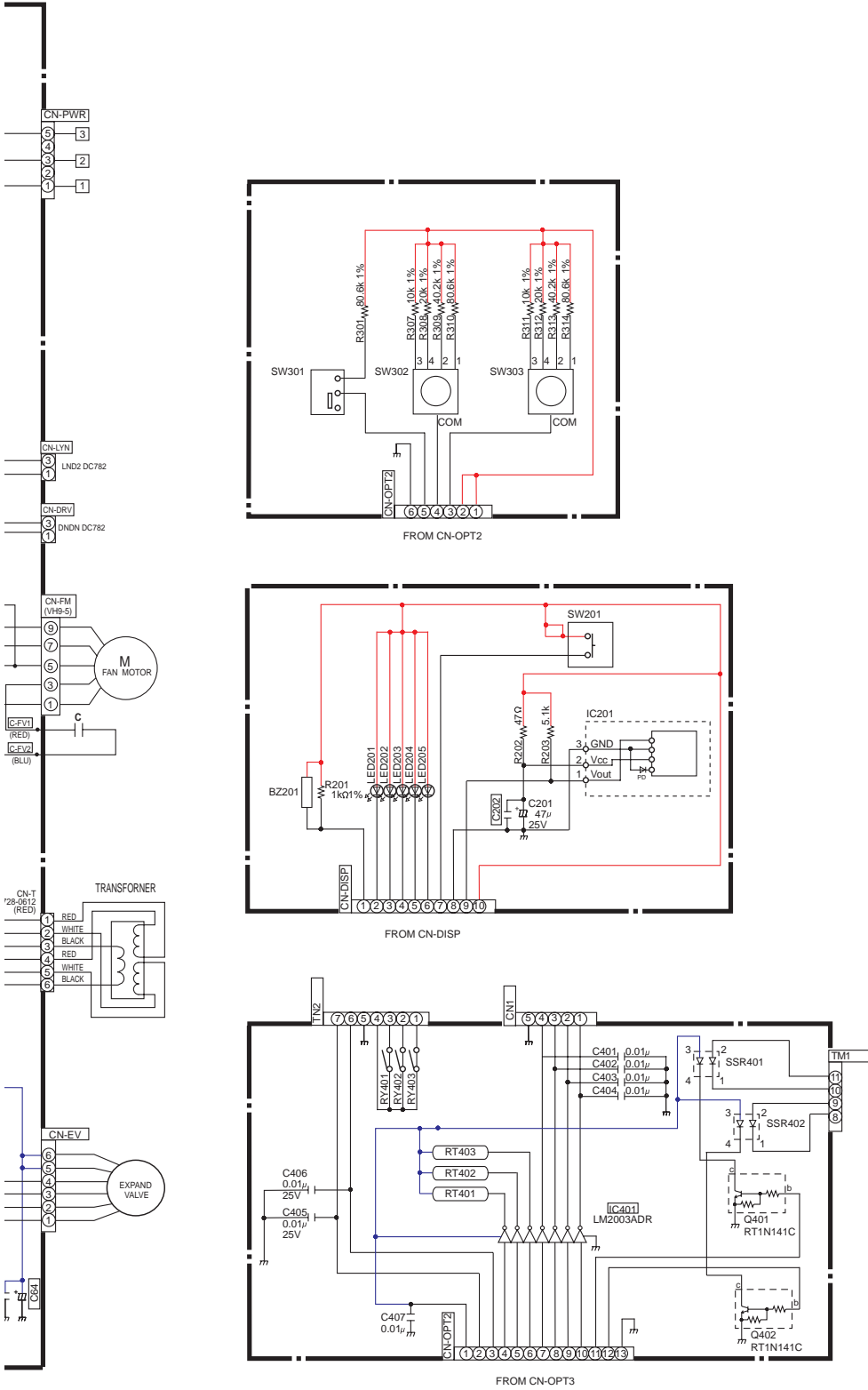

14.2. Outdoor unit

** Electronic Circuit Diagram

*** CU-L50DBE8

SCHEMATIC DIAGRAM 1/5

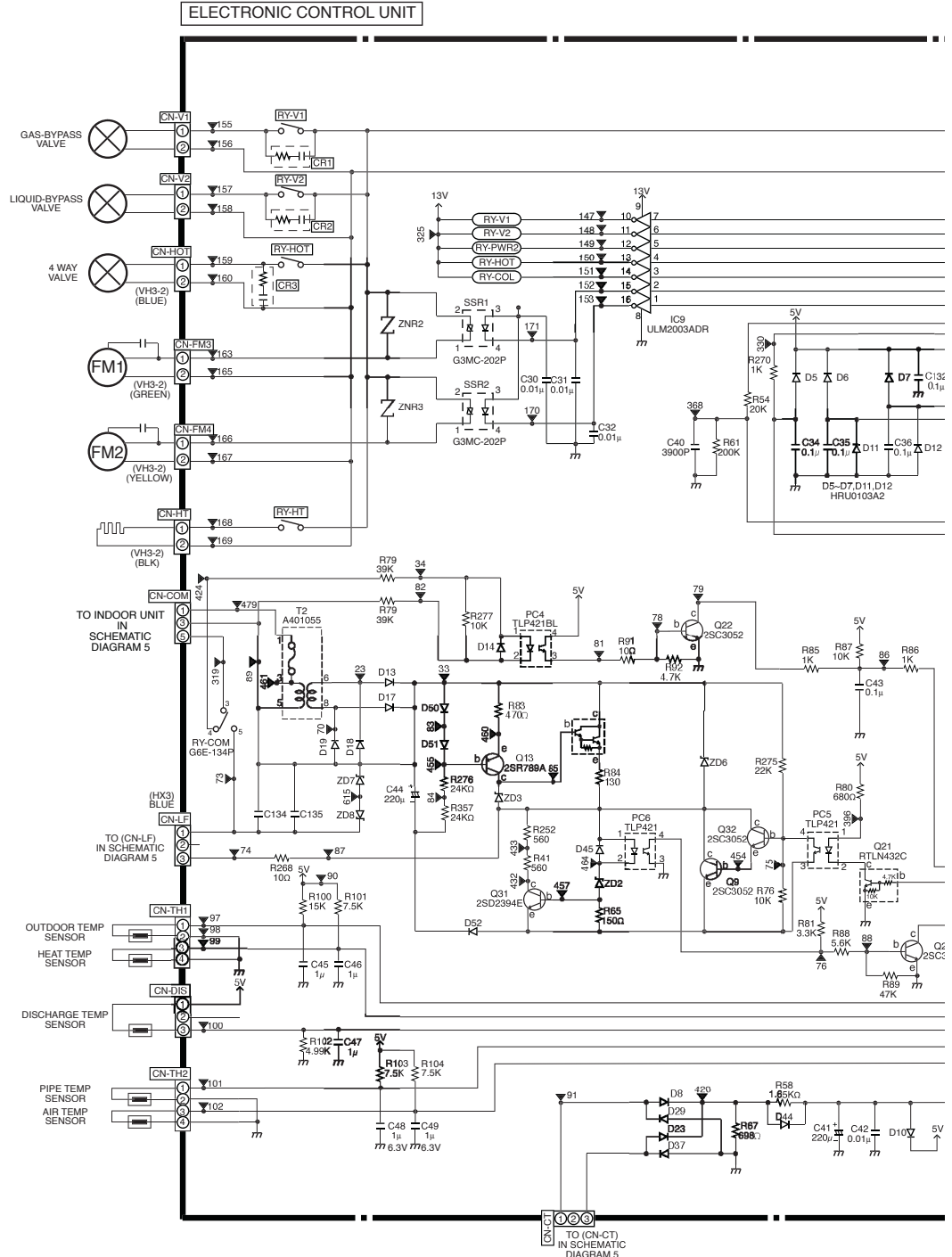

SCHEMATIC DIAGRAM 2/5

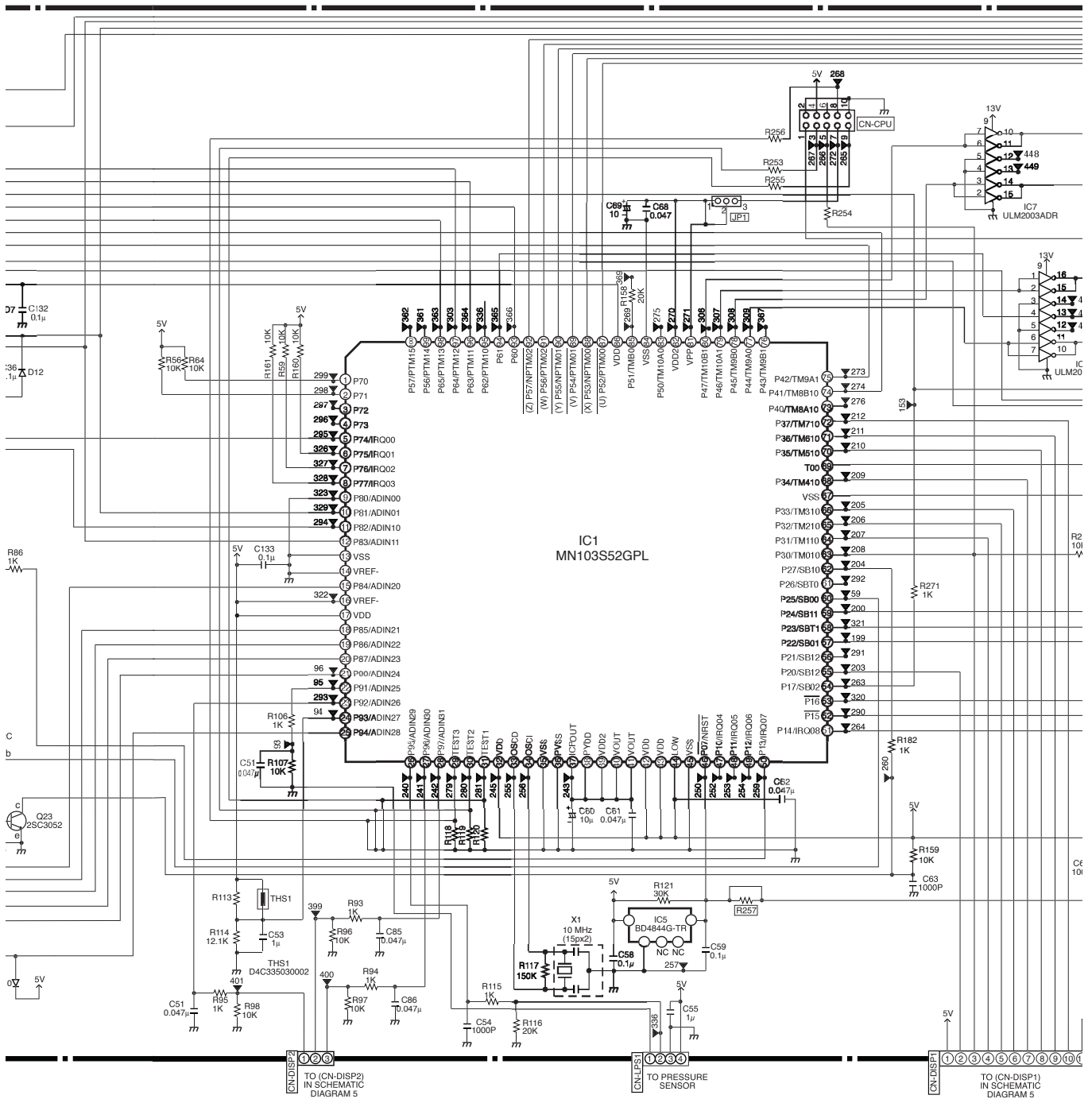

SCHMATIC DIAGRAM 3/5

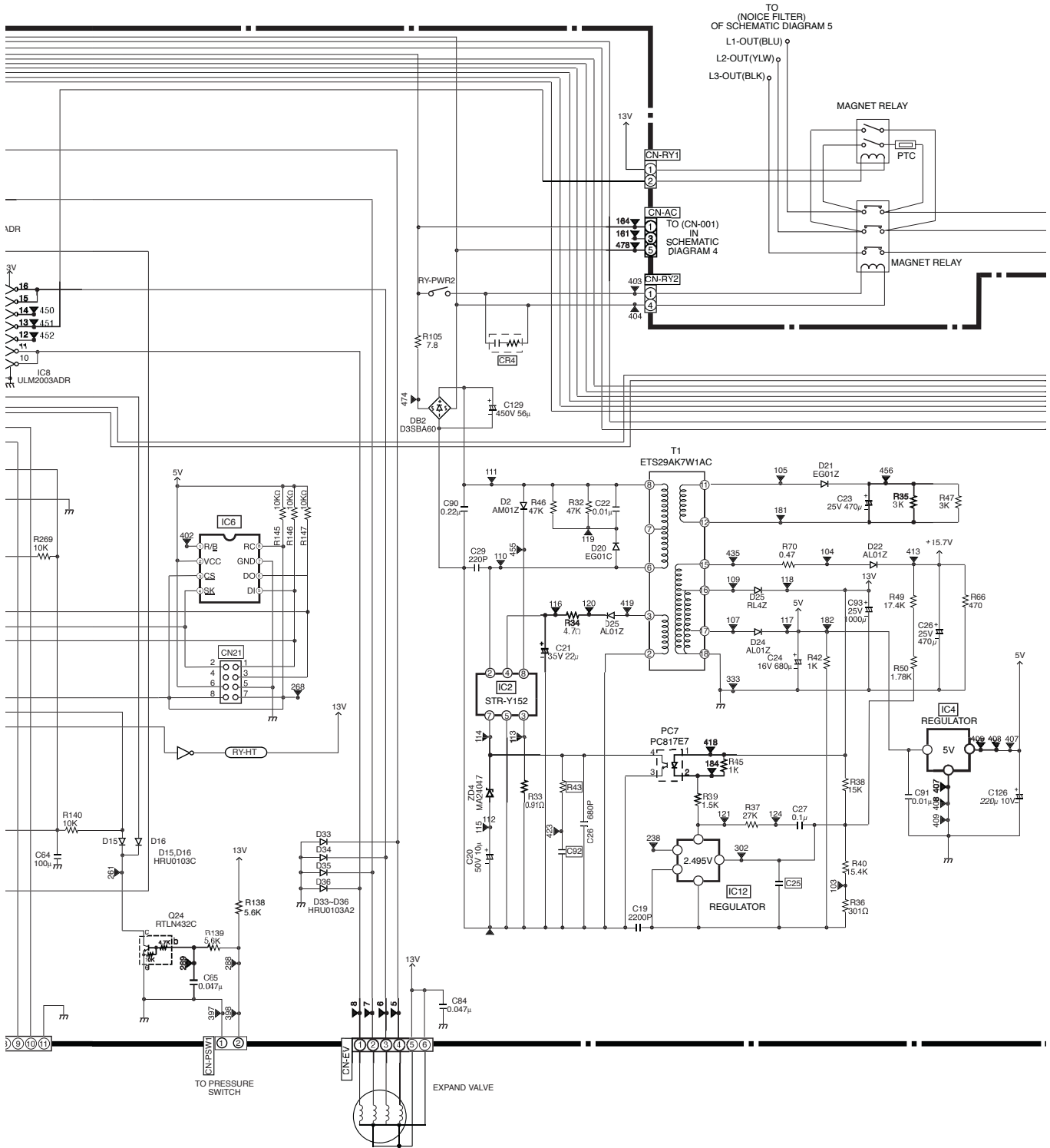

SCHEMATIC DIAGRAM 4/5

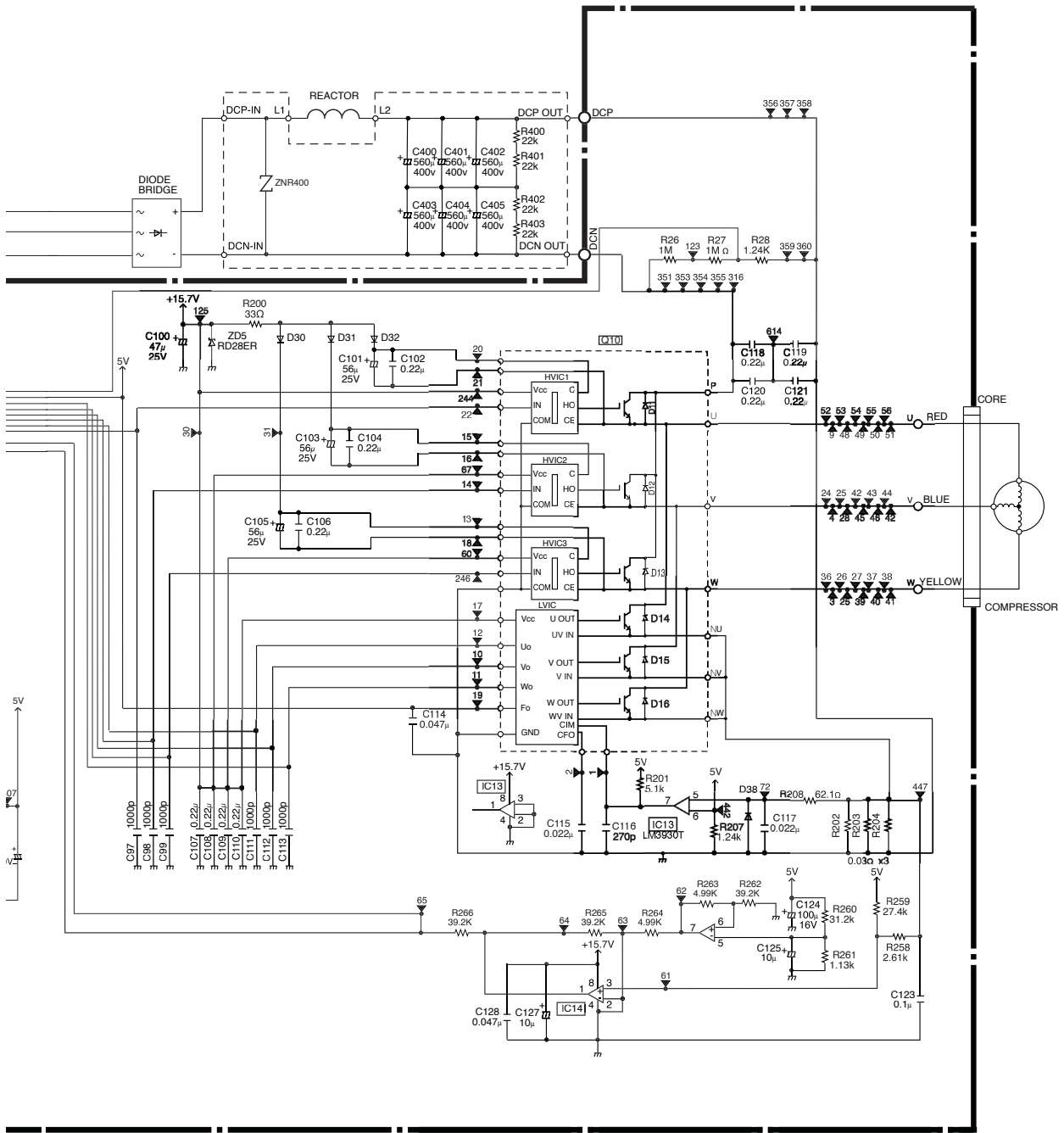

SCHEMATIC DIAGRAM 5/5

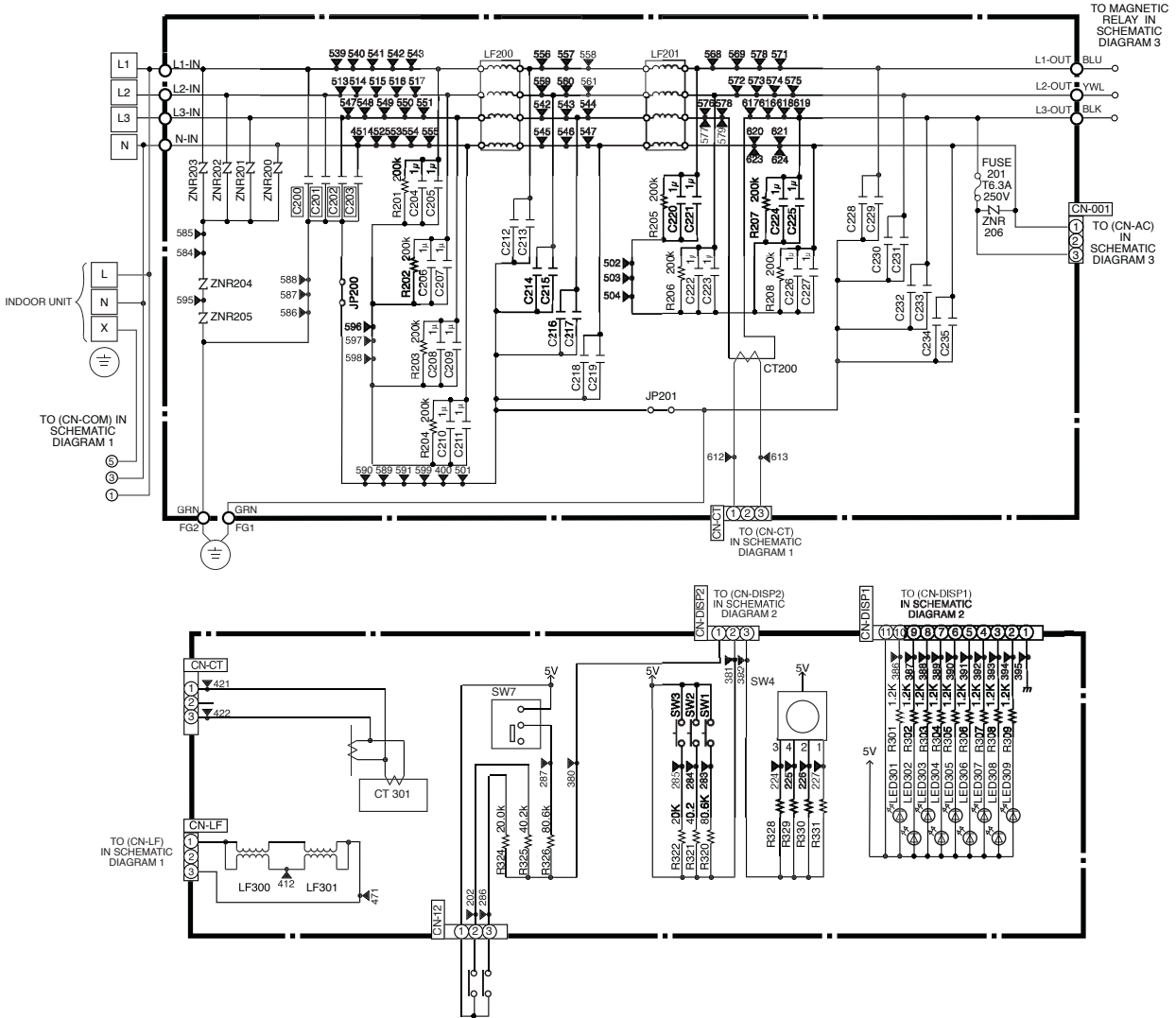

14.3. Wired remote control

● WIRED REMOTE CONTROL PRINTED CIRCUIT BOARD (SCHEMATIC DIAGRAM)

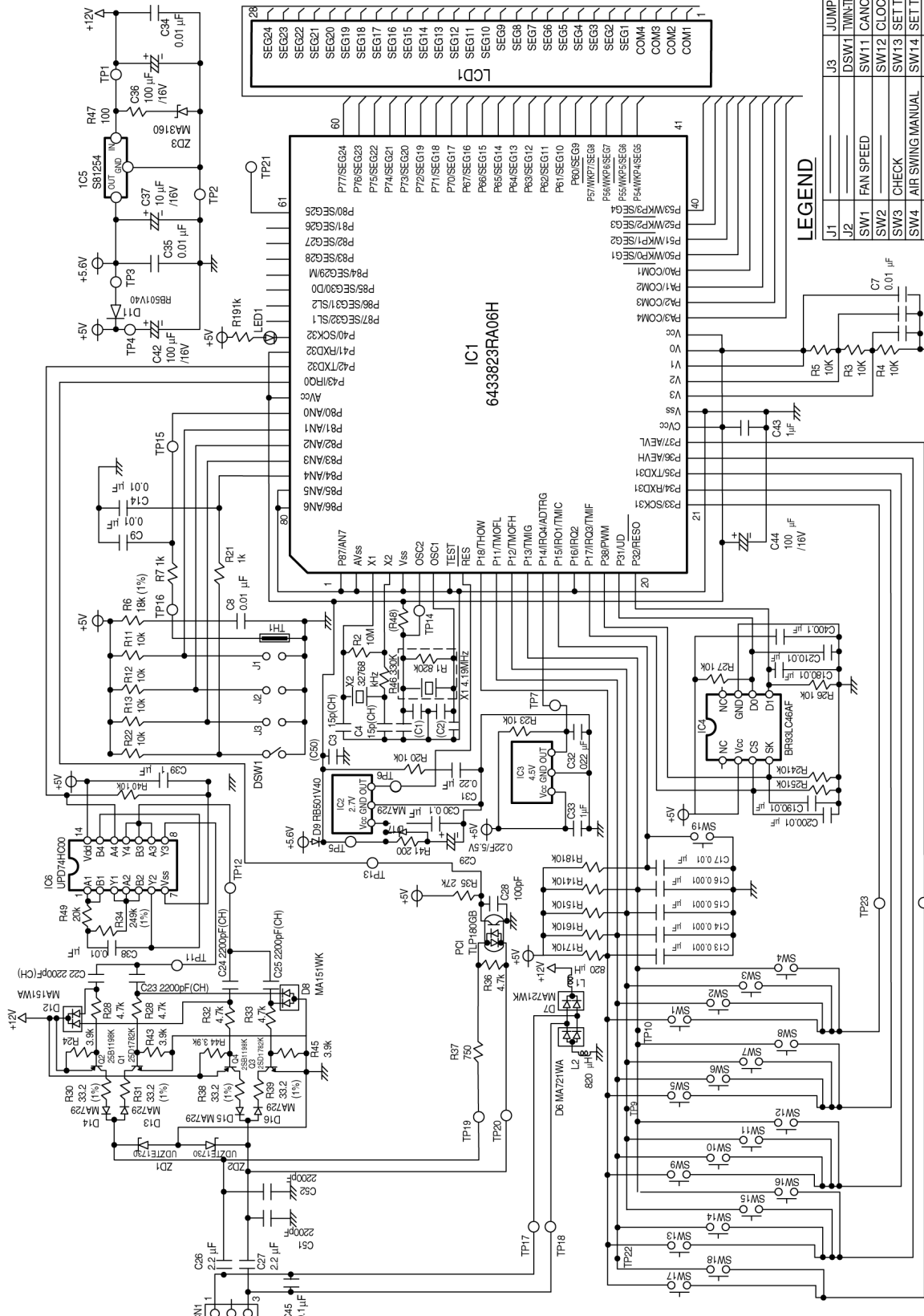

LEGEND

J1	JUMPER
J2	TWIN/TWIRPLE SETTING(S.W.E. OFF/MAN)
J3	DSW1
SW1	FAN SPEED
SW2	CANCEL
SW3	CLOCK
SW4	CHECK
SW5	SET TEMPERATURE UP
SW6	SET TEMPERATURE DOWN
SW7	FAIR SWING MANUAL OPERATION
SW8	FILTER RESET
SW9	TEST RUN
SW10	SW17 (TO SET A LATER TIME)
SW11	SW18 (TO SET AN EARLIER TIME)
SW12	SW19 OFF / ON
SW13	SW20 SET

- INDOOR UNIT
PRINTED CIRCUIT BOARD (INDICATOR)

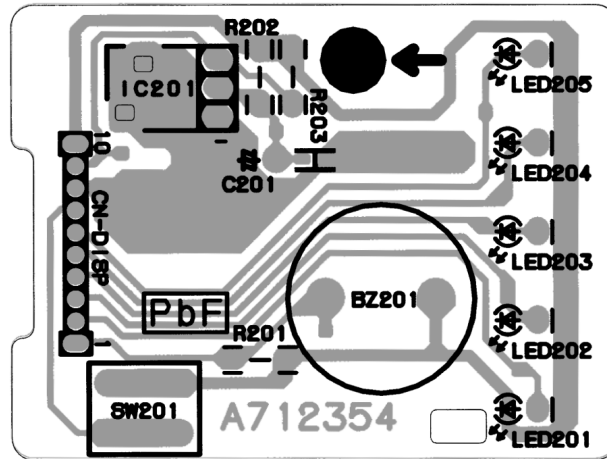

- OUTDOOR UNIT
PRINTED CIRCUIT BOARD (POWER)

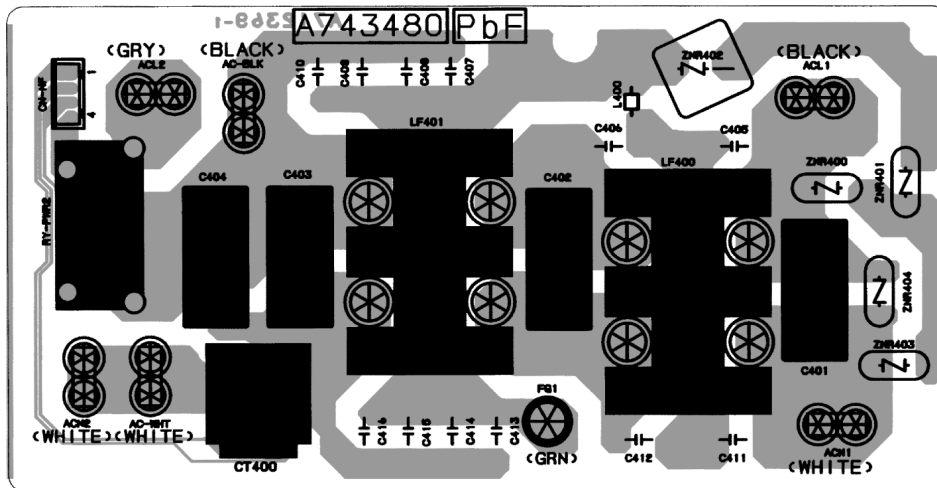

- OUTDOOR UNIT
PRINTED CIRCUIT BOARD (SERVICE)

